

BEST SELLER'S GUIDE

PROFESSIONAL TOOLS FOR INDUSTRIAL APPLICATIONS



FALCON Tool Company



HOW TO ORDER

SHOP ONLINE CATALOG

- Use our online catalog at **FalconTool.com** and pay with a credit card. Sign up for an account to view previous orders.

CONTACT CUSTOMER SERVICE

- Order via phone, email or fax. Phone: 800.321.8512 Fax: 216.328.1180
Email: customerservice@falcontool.com.

BUSINESS ACCOUNTS

- If you are interested in setting up a Business Credit Account, please apply online via our Business Credit Application Page or contact us at 800.321.8512 or customerservice@falcontool.com.

FREIGHT

- All shipments F.O.B. Traverse City. Shipments made by UPS. See our online Delivery Information page for delivery times using standard ground shipment. UPS 2-Day and Next Day services also offered for most destinations.

RETURNED MERCHANDISE POLICY

Returns must be authorized by a Falcon Representative within one week of receipt of merchandise. Unauthorized returns will not be accepted. Items returned are subject to a 25% restocking fee.

NOTE: Prices in this catalog are the prices current at the time of printing. All prices are subject to change without notice.



Information Sheet

CODE	COLOR	AVAILABLE GRITS
N	Tan	100 – 150 – 220 – 320 – 400 – 500 – 600
R	Pink	46 – 60 – 80 – 100 – 150 – 220
SO	Grey	46 – 60 – 80 – 100 – 150 – 220 – 320 – 400 – 500 – 600
HA	Cream	100 – 150 – 220 – 320 – 400 – 500 – 600
SE	White	100 – 150 – 220 – 320 – 400 – 500 – 600 – 800 – 900 – 1000
EDM	Dark Brown	100 – 150 – 220 – 320 – 400 – 500 – 600
B	Light Brown	320 – 400 – 600
PO	Blue-Grey	150 – 220 – 320 – 400 – 500 – 600
PRO	White	120 – 150 – 220 – 320 – 400 – 600 – 800 – 1000 – 1200
Roughing	Black, White, Orange, Blue, Green	80 – 100 – 120 – 180

CODE	APPLICATIONS
N	Fast cutting and general polishing.
R	Extremely fast cutting action - use dry - should be used where fast rate of stock removal is desired.
SO	Regular silicon carbide for general polishing.
HA	Hard structured aluminum oxide for polishing slots, ribs, letters and hard to get at places.
SE	Semi-hard aluminum oxide for general polishing - load resistant.
EDM	Special aluminum oxide stone for polishing electrical discharge machine surfaces.
B	An extremely hard bonded aluminum oxide. Will hold shape and give a fine finish.
PO	Softer silicon carbide with porous structure for even breakdown and fine velvet finish.
PRO	All-around aluminum oxide stone pre-filled with lubricant so no lengthy pre-lubrication is required.
Roughing	From soft to hard the Roughing stones enable rapid, aggressive stock removal.

NOTE: Polishing Stones are sold in a minimum order quantity of 12 pcs/box per size & grit with the exception of 1x1x6 stones which will have a minimum order quantity of 6pcs/box per size and grit and 1x2x6 which will have a minimum order quantity of 3pcs/box per size and grit. All Falcon Polishing Stones with the exception of the "R" series (Pink Stone) should be used with Falcon Stoning Oil on page 16. The "R" series (Pink Stone) may be used dry.

Polishing Stone Assortment Sets

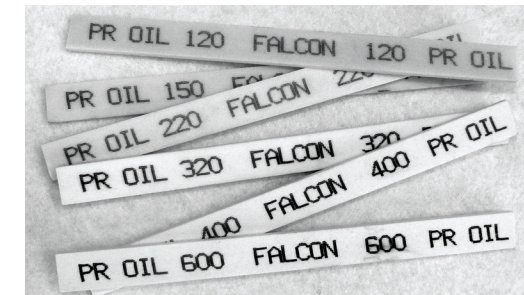

Premium Oil Stone Regular Grit Set

Falcon's new Polishing Stone Assortment Sets offer one stone of each grit in size 1/8 x 1/2 x 6 allowing you to try a variety of grits without having to purchase a full box of one size and grit.

Regular Grit Sets offer the same sizes and grits for each polishing stone type: one 1/8 x 1/2 x 6 in 150, 220, 320, 400, & 600 grits. Fine Grit Sets are available for the SE and Premium Oil Polishing Stones and include 1/8 x 1/2 x 6 stones in grits:

SE: 320, 400, 600, 800, and 1000

Premium Oil: 320, 400, 600, 800, 1000, and 1200

STONE TYPE	ORDER NO.	PRICE
N	02A-NDS9000	\$9.40 ea
SO	02B-SOS9000	\$9.40 ea
HA	02D-HAS9000	\$10.10 ea
SE	02E-SES9000	\$10.10 ea
SE Fine Grit	02E-SES9100	\$12.00 ea

STONE TYPE	ORDER NO.	PRICE
EDM	02F-EDM9000	\$9.70 ea
PO	02C-POS9000	\$9.40 ea
Premium Oil	02T-PRO9001	\$14.89 ea
Premium Oil Fine Grit	02T-PRO9000	\$17.89 ea

Polishing Stone Holders

Perfect for hand polishing with Falcon Polishing Stones



ORDER NO.	DIMENSIONS (MM)	PRICE
02N-HDR5000	Holder for 1/8x1/4, 1/4x1/4 and 1/8x1/2 Stones	\$4.67
02N-HDR5001	Holder for 1/4x1/4 and 1/4x1/2 Stones	\$4.67
02N-HDR5002	Holder for 3/8" and 1/4" Round Stones	\$4.67
02N-HDR5003	Holder for 1/16x1/4 and 1/16x1/2 Stones	\$4.67
02N-HDR5004	Kit containing one of each holder size	\$17.24

Stone Holders for use with Air Profilers

Use with Air Profilers starting on page 107.

ORDER NO.	DESCRIPTION	PRICE
02N-HDR5005	Holder for Profiler, 3/16" Shank, for 1/8x1/4 stones	\$5.85
02N-HDR5006	Holder for Profiler, 3/16" Shank, for 1/8x1/2 & 1/4x1/4 stones	\$5.85
02N-HDR5007	Holder for Profiler, 1/8" Shank, for 1/8x1/4 stones	\$5.85
02N-HDR5008	Holder for Profiler, 1/8" Shank, for 1/8x1/2 & 1/4x1/4 stones	\$5.85
02N-HDR5009	Vice Clamp Holder for Profiler, 3/16" Shank	\$28.05
02N-HDR5010	Vice Clamp Holder for Profiler, 1/8" Shank	\$28.05
02N-HDR5020	Ceramic Stone Holder for Profilers, 1/8" Shank	\$29.27
02N-HDR5021	Ceramic Stone Holder for Profilers, 3mm Shank	\$25.03
02N-HDR5022	Ceramic Stone Holder for Profilers, 3/16" Shank	\$26.26
02N-HDR5023	Brass Ring Replacement for Stone Holder	\$12.21
02N-HDR5024	Large Brass Ring Replacement for Stone Holder	\$23.25
02N-HDR5025	Holder for Profiler, Long, 3/16" Shank, for 1/4" stones	\$31.75
02N-HDR5026	Holder for Profiler, Short, 3/16" Shank, for 1/4" stones	\$31.75
02N-HDR5027	Holder for Profiler, Short, 3/16" Shank, for 1/8" stones	\$30.54
02N-HDR5028	Holder for Profiler, 1/8" Shank, for 1/4" x 1/2" stones	\$14.58



Falcon "N" Diemaker Stones

Aluminum Oxide • An extra fine polishing stone for molds and dies • 6" long • Tan to Brown Color

PRICE EACH IN GRITS / ORDER NO.

Table with 8 columns: SIZE (IN), 100, 150, 220, 320, 400, 500, 600. Rows include various sizes like 1/16 X 1/4, 1/8 X 1/8, 1/4 X 1, 1 X 1, and Round sizes like 3/16 DIA., 1/4 DIA., 3/8 DIA., 1/2 DIA.

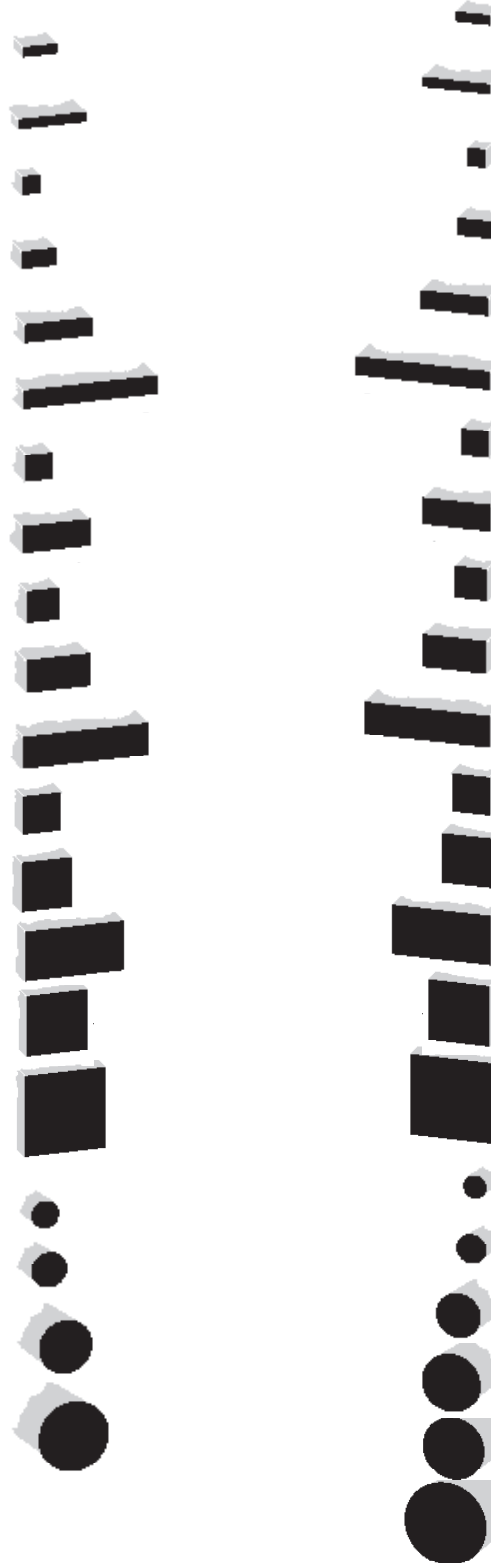

Falcon "SO" Moldmaker Stones

Silicon Carbide • Grey Color • 6" Long

PRICE EACH IN GRITS / ORDER NO.

Table with 6 columns: SIZE (IN), 46, 60, 80, 100, 150. Rows include various sizes like 1/16 X 1/4, 1/8 X 1/8, 1/4 X 1, 1 X 1, and Round sizes like 3/16 DIA., 1/4 DIA., 3/8 DIA., 1/2 DIA., 3/4 DIA., 1 DIA.

NOTE: Polishing Stones are sold in a minimum order quantity of 12 pcs/box per size & grit with the exception of 1x1x6 which will have a minimum order quantity of 6pcs/box per size and grit and 1x2x6 which will have a minimum order quantity of 3pcs/box per size and grit. See page 16 for Quantity Discounts.



Falcon “SO” Moldmaker Stones

Silicon Carbide • Grey Color • 6” Long

PRICE EACH IN GRITS / ORDER NO.

Table with columns: SIZE (IN), 220, 320, 400, 500, 600. Rows include sizes from 1/16 X 1/4 to 1 X 1 with corresponding prices and order numbers.

Round

Table with columns: SIZE (IN), 220, 320, 400, 500, 600. Rows include round sizes from 3/16 DIA. to 1 DIA. with corresponding prices and order numbers.

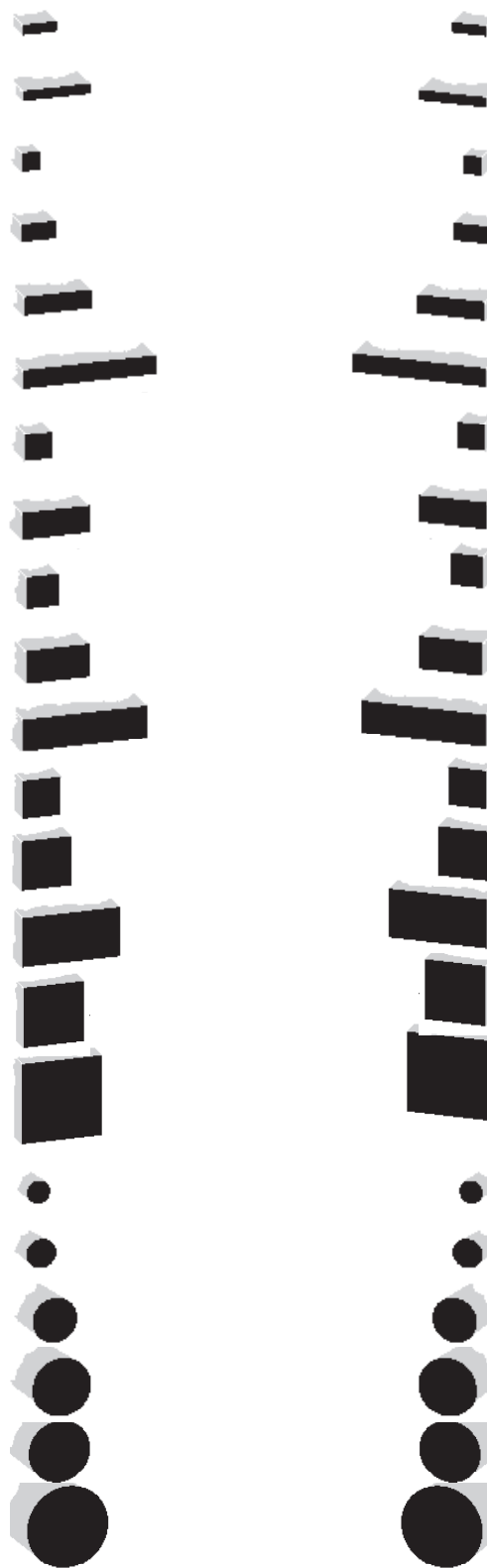

Falcon “PO” Moldmaker Stones

Silicon Carbide • Blue-Grey Color • 6” Long

PRICE EACH IN GRITS / ORDER NO.

Table with columns: SIZE (IN), 150, 220, 320, 400, 500, 600. Rows include sizes from 1/16 X 1/4 to 1 X 1 with corresponding prices and order numbers.

Round

Table with columns: SIZE (IN), 150, 220, 320, 400, 500, 600. Rows include round sizes from 3/16 DIA. to 1 DIA. with corresponding prices and order numbers.



Falcon “HA” Hard Structured Stones

For Ribs • Slots • Letters • 6” Long • Use in Blind Spots, Hard to Reach Places • Holds Corners • Cream Color

Table with columns: SIZE (IN), 100, 150, 220, 320, 400, 500, 600. Rows include sizes like 1/16 X 1/4, 1/16 X 1/2, 1/8 X 1/8, etc.

Round

Table with columns: DIA., 100, 150, 220, 320, 400, 500, 600. Rows include sizes like 3/16 DIA., 1/4 DIA., 3/8 DIA., 1/2 DIA.

NOTE: Polishing Stones are sold in a minimum order quantity of 12 pcs/box per size & grit with the exception of 1x1x6 stones which will have a minimum order quantity of 6pcs/box per size and grit and 1x2x6 which will have a minimum order quantity of 3pcs/box per size and grit. See page 16 for Quantity Discounts.

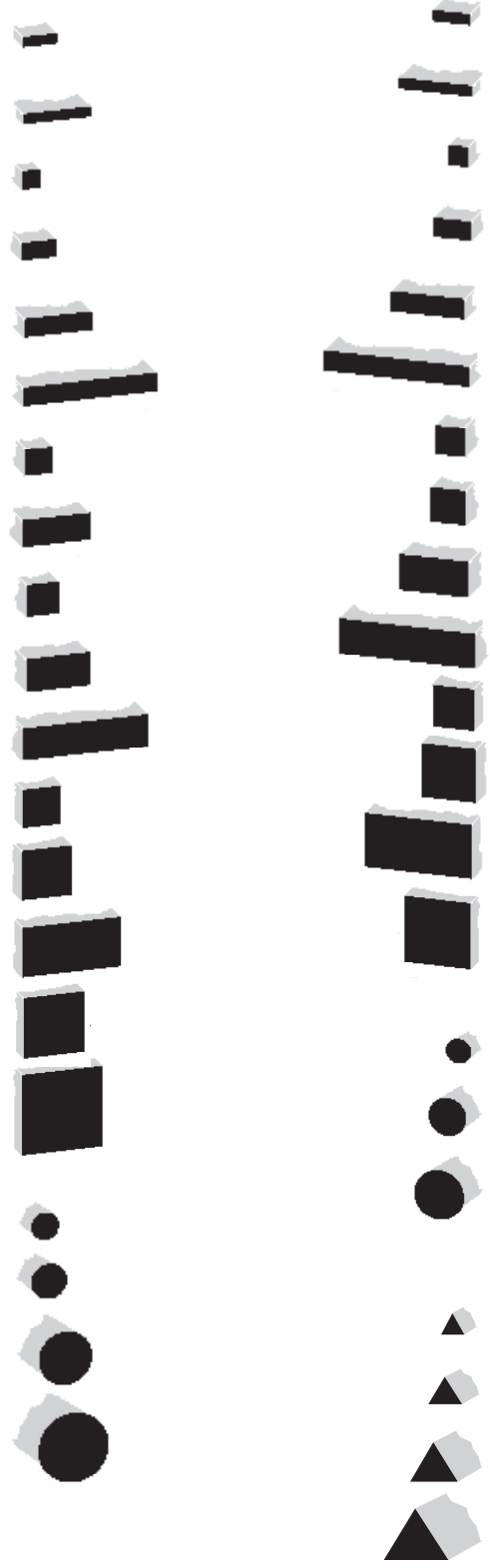

Table with columns: SIZE (IN), 120, 150, 220. Rows include sizes like 1/16 X 1/4 X 6, 1/16 X 1/2 X 6, 1/8 X 1/8 X 6, etc.

Round

Table with columns: SIZE (IN), 120, 150, 220. Rows include sizes like 1/4 X 5.5 ROUND, 3/8 X 5.5 ROUND, 1/2 X 5.5 ROUND.

Triangle

Table with columns: SIZE (IN), 120, 150, 220. Rows include sizes like 1/4 X 6 TRIANGLE, 3/8 X 6 TRIANGLE, 1/2 X 6 TRIANGLE, 1 X 6 TRIANGLE.

Falcon “Premium Oil” Polishing Stone

Excellent Breakdown Characteristics • Retains Shape • Pre-filled with Lubricant • White Color • 6” Long

- Retains shape well - especially when polishing mold cavity details
• Filled with lubricant during the manufacturing process so no pre-lubrication required
• 220 grit is an ideal “start up stone” for machined surfaces
• Use of lubricant for all grit sizes is recommended
• 220 and 320 grits work well in removing EDM scale
• See page 5 for other stone kits

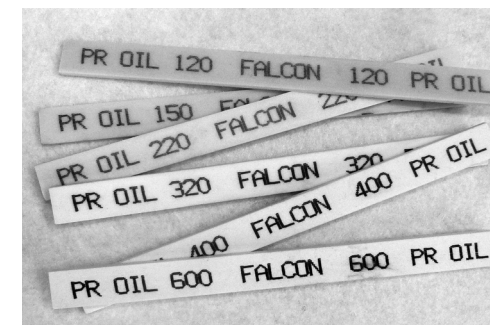

PRO Stone Kits

Kits offer a selection of grits in the 1/8” x 1/2” x 6” size. 1 stone of each grit.

STANDARD GRIT KIT \$14.89
150, 220, 320, 400 and 600 grits
Order No. 02T-PRO9001

FINE GRIT KIT \$17.89
320, 400, 600, 800, 1000 and 1200 grits
Order No. 02T-PRO9000

NOTE: Polishing Stones are sold in a minimum order quantity of 12 pcs/box per size & grit with the exception of 1x1x6 stones which will have a minimum order quantity of 6pcs/box per size and grit and 1x2x6 which will have a minimum order quantity of 3pcs/box per size and grit. See page 16 for Quantity Discounts.



Falcon "Premium Oil" Polishing Stones

Excellent Breakdown Characteristics • Retains Shape • Pre-filled with Lubricant • White Color • 6" Long

PRICE EACH IN GRITS / ORDER NO.

Table with columns: SIZE (IN), 320, 400, 600, 800, 1000, 1200. Rows include various sizes like 1/16 X 1/4 X 6, 1/8 X 1/8 X 6, 1/4 X 1/4 X 6, 1 X 1 X 6, and shapes like Round and Triangle.

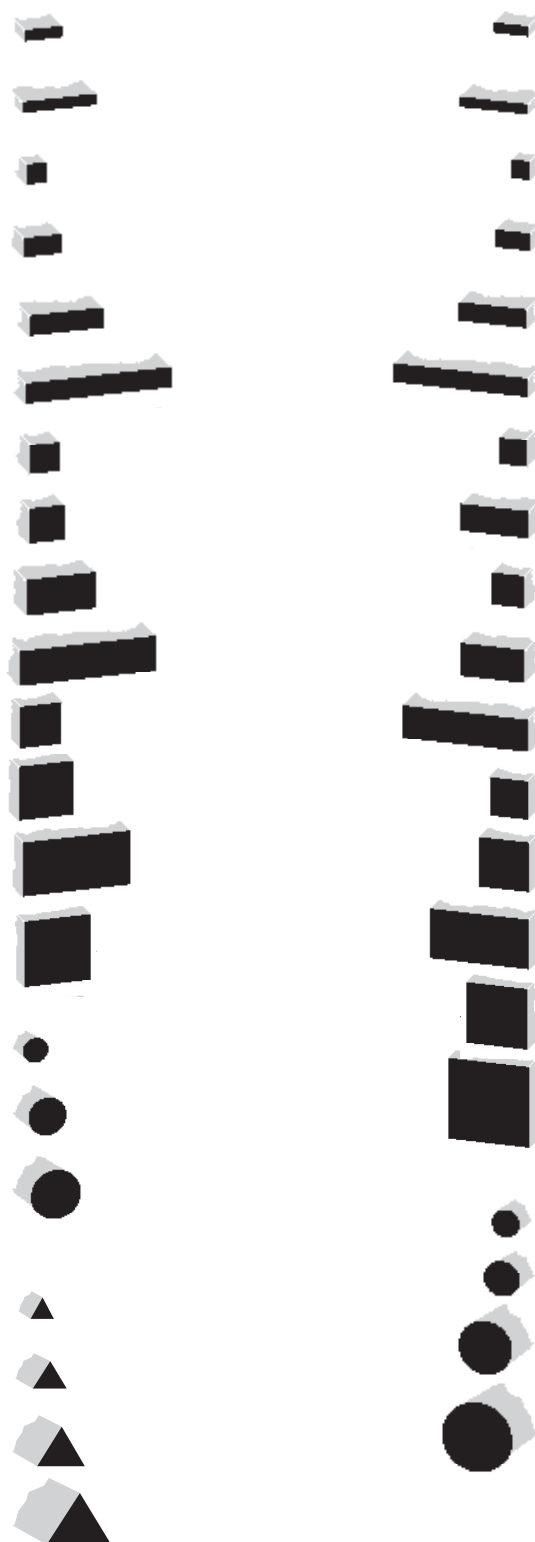

Falcon "SE" General Polishing Stones

Semi-Hard Aluminum Oxide • Load Resistant • White Color • 6" Long

PRICE EACH IN GRITS / ORDER NO.

Table with columns: SIZE (IN), 100, 150, 220, 320, 400. Rows include various sizes like 1/16 X 1/4, 1/8 X 1/8, 1/4 X 1/4, 1 X 1, and Round shapes.

NOTE: Polishing Stones are sold in a minimum order quantity of 12 pcs/box per size & grit with the exception of 1x1x6 stones which will have a minimum order quantity of 6pcs/box per size and grit and 1x2x6 which will have a minimum order quantity of 3pcs/box per size and grit. See page 16 for Quantity Discounts.



Falcon "SE" General Polishing Stones

Semi-Hard Aluminum Oxide • Load Resistant • White Color • 6" Long

PRICE EACH IN GRITS / ORDER NO.

Table with columns: SIZE (IN), 500, 600, 800, 900, 1000. Lists various sizes and grits with prices and order numbers.

Round

Table with columns: SIZE (IN), 500, 600, 800, 900, 1000. Lists round stone sizes and grits with prices and order numbers.

NOTE: Polishing Stones are sold in a minimum order quantity of 12 pcs/box per size & grit with the exception of 1x1x6 stones which will have a minimum order quantity of 6pcs/box per size and grit and 1x2x6 which will have a minimum order quantity of 3pcs/box per size and grit. See page 16 for Quantity Discounts.

Falcon "EDM" Polishing Stones

For Polishing Electrical Discharge Machined Surfaces • Dark Brown Color • Penetrates Surface Scale Easily • 6" Long

PRICE EACH IN GRITS / ORDER NO.

Table with columns: SIZE (IN), 100, 150, 220, 320, 400, 500, 600. Lists EDM stone sizes and grits with prices and order numbers.

Falcon "B" Resin Bonded Stones

Light Brown Color • 6" Long • An Extremely Hard Bonded Aluminum Oxide • Holds Shape • Gives Fine Finish

PRICE EACH IN GRITS / ORDER NO.

Table with columns: SIZE (IN), 320, 400, 600. Lists resin bonded stone sizes and grits with prices and order numbers.

NOTE: Polishing Stones are sold in a minimum order quantity of 12 pcs/box per size & grit with the exception of 1x1x6 stones which will have a minimum order quantity of 6pcs/box per size and grit and 1x2x6 which will have a minimum order quantity of 3pcs/box per size and grit. See page 16 for Quantity Discounts.



Falcon "R" Ruby Stones

Extremely Fast Cutting • Pink in Color • May be used dry • 6" Long

Table with columns: SIZE (IN), 46, 60, 80, 100, 150, 220. Lists various sizes and grits of polishing stones with their respective prices.



* 8" Long

POLISHING STONE QUANTITY DISCOUNTS

48+ PIECES OF THE SAME 10% 96+ PIECES OF THE SAME 20%

POLISHING STONE DISCOUNT APPLIES TO PAGES 6 THROUGH 16

Falcon Stoning Oil and Diamond Compound Thinner

A special stoning oil developed for easier die and mold finishing. Recommended for use with all Falcon polishing stones. Helps prevent loading, cuts better, more efficiently.



Table with columns: SIZE, ORDER NO., PRICE. Lists sizes (6 oz, 1 pint, 1 quart, 1 gallon) and their corresponding order numbers and prices.

Falcon "Roughing" Stones

From soft to hard, Roughing Stones enable rapid, aggressive stock removal. Excellent for roughing large molds and dies.

Table with columns: PRICE EACH IN GRIT / ORDER NO., 80, 100, 120, 150, 180, 220. Lists various sizes and grits of roughing stones with their respective prices.

Sharpening Stones

Used for deburring, sharpening and honing. Oil treated for quick, non-loading tool sharpening.

Combination Bench Sharpening Stone (Grit 120/320) 1 piece per box

Table with columns: Part No., Material, Size, Order No., Price. Lists various bench sharpening stones.

Combination Round Knife Stone (Grit 120/320) 1 piece per box

Table with columns: Part No., Material, Size, Order No., Price. Lists a round knife stone.

Falcon Pencil Stones

Complete Selection • 6" Long • 5/32" Square



TYPE	DESCRIPTION & COLOR	GRIT 150	GRIT 220	GRIT 320	GRIT 400	GRIT 500	GRIT 600	PRICE 12/PCS
N	Aluminum Oxide Tan to Brown	02I-PEN1000	02I-PEN1001	02I-PEN1002	02I-PEN1003	02I-PEN1004	02I-PEN1005	\$20.28
R	Aluminum Oxide Pink	02I-PEN1100	02I-PEN1101	--	--	--	--	\$20.28
SO	Silicon Carbide Grey	02I-PEN1200	02I-PEN1201	02I-PEN1202	02I-PEN1203	02I-PEN1204	02I-PEN1205	\$20.64
HA	Aluminum Oxide Cream	02I-PEN1300	02I-PEN1301	02I-PEN1302	02I-PEN1303	02I-PEN1304	02I-PEN1305	\$18.48
EDM	Aluminum Oxide Dark Brown	02I-PEN1500	02I-PEN1501	02I-PEN1502	02I-PEN1503	02I-PEN1504	02I-PEN1505	\$20.28
B	Aluminum Oxide Light Brown	--	--	02I-PEN1600	02I-PEN1601	--	02I-PEN1602	\$20.28
SE	Aluminum Oxide White	02I-PEN1400	02I-PEN1401	02I-PEN1402	02I-PEN1403	02I-PEN1404	02I-PEN1405	\$20.28

TYPE	DESCRIPTION & COLOR	GRIT 800	GRIT 900	GRIT 1000	PRICE 12/PCS
SE	Extra Fine, White	02I-PEN1406	02I-PEN1407	02I-PEN1408	\$20.28

QUANTITY DISCOUNTS 48+ PIECES OF THE SAME 10% 96+ PIECES OF THE SAME 20%

Falcon Pencil Stone Holders

Pencil Stone • Use for 5/32" Square, 1/4" Diameter Sizes

 Style No. #101
 Order No. 02Z-MSC1100
 \$7.60 each

Double End • Use for 1/4" x 1/4", 1/16" x 1/4" and 1/8" x 1/4"

 Style No. #104
 Order No. 02Z-MSC1200
 \$5.55 each

Ceramic Super Stone Sets & Holders
NEW STONES PERFECT FOR FINE DETAIL POLISHING

Strong, flexible and non-loading on all types of materials, Ceramic Super Stones are extremely strong and thin for use in tight ribs and slots. Excellent for EDM removal. Sets and holders on this page. Individual stones on following two pages.

Ceramic Super Stone Sets

An economical way to have a variety of stones on hand to meet any polishing need. (each set contains one piece of each stone)

Ceramic Super Stone Sets

ORDER NO.	DIMENSIONS (MM)	GRITS	PRICE
02M-CKT9001	1 x 4 x 100	120, 180, 300, 800, 1000	\$89.95
02M-CKT9002	1 x 6 x 100	120, 180, 300, 800, 1000	\$138.00

Miniature Ceramic Super Stone Sets

ORDER NO.	DIMENSIONS (MM)	GRITS	PRICE
02M-CKT9003	0.5 x 0.5 x 50	120, 300, 600, 1200	\$28.25
02M-CKT9004	0.7 x 0.7 x 50	120, 300, 600, 1200	\$28.25

Stone Holders for Ceramic Super Stones and Cristone® Products

Plastic stone holders for hand polishing with Ceramic Super Stones, Miniature Ceramic Super Stones and Cristone® Crystal Fiber Stones are essential for good control during the polishing process.

Ceramic Super Stone & Cristone® Holders

ORDER NO.	DIMENSIONS (MM)	PRICE
02N-HDR5011	3 (round)	\$8.43
02N-HDR5012	4	\$6.04
02N-HDR5013	6	\$6.04
02N-HDR5014	10	\$6.04
02N-HDR5015	Set Including 4, 6 & 10 mm holders	\$15.88

Miniature Ceramic Super Stone Holders

ORDER NO.	DIMENSIONS (MM)	PRICE
02N-HDR5016	0.5 x 0.5	\$10.60
02N-HDR5017	0.7 x 0.7	\$10.60
02N-HDR5018	0.9 x 0.9	\$10.60
02N-HDR5019	1.4 x 1.4	\$10.60



NEW STONES PERFECT FOR FINE DETAIL POLISHING

Strong, flexible and non-loading on all types of materials, Ceramic Super Stones are extremely strong and thin for use in tight ribs and slots. Excellent for EDM removal. For Ceramic Super Stone Sets & Stone Holders, see page 19.

NEW STONES PERFECT FOR FINE DETAIL POLISHING

Strong, flexible and non-loading on all types of materials, Ceramic Super Stones are extremely strong and thin for use in tight ribs and slots. Excellent for EDM removal. For Ceramic Super Stone Sets & Stone Holders, see page 19.

Ceramic Super Stones									
SHAPE	DIMENSIONS (MM)	GREEN (120 GRIT)	GOLD (180 GRIT)	LT. BROWN (300 GRIT)	ORANGE (400 GRIT)	BLACK (600 GRIT)	BLUE (800 GRIT)	WHITE (1000 GRIT)	RED (1200 GRIT)
Flat	0.5 x 2 x 100	02M-CGR1004 \$14.00	02M-CGO1104 \$14.00	02M-CBR1204 \$14.00	02M-COR1304 \$14.00	02M-CBK1404 \$14.00	02M-CBL1504 \$13.00	02M-CWH1604 \$13.00	02M-CRD1704 \$13.00
Flat	0.5 x 4 x 100	02M-CGR1005 \$21.00	02M-CGO1105 \$21.00	02M-CBR1205 \$21.00	02M-COR1305 \$21.00	02M-CBK1405 \$21.00	02M-CBL1505 \$20.00	02M-CWH1605 \$20.00	02M-CRD1705 \$20.00
Flat	0.5 x 6 x 100	02M-CGR1006 \$32.00	02M-CGO1106 \$32.00	02M-CBR1206 \$32.00	02M-COR1306 \$32.00	02M-CBK1406 \$32.00	02M-CBL1506 \$31.00	02M-CWH1606 \$31.00	02M-CRD1706 \$31.00
Flat	0.8 x 4 x 100	02M-CGR1007 \$22.00	02M-CGO1107 \$22.00	02M-CBR1207 \$22.00	02M-COR1307 \$22.00	02M-CBK1407 \$22.00	02M-CBL1507 \$21.00	02M-CWH1607 \$21.00	02M-CRD1707 \$21.00
Flat	0.8 x 6 x 100	02M-CGR1008 \$32.00	02M-CGO1108 \$32.00	02M-CBR1208 \$32.00	02M-COR1308 \$32.00	02M-CBK1408 \$32.00	02M-CBL1508 \$32.00	02M-CWH1608 \$32.00	02M-CRD1708 \$32.00
Flat	0.8 x 10 x 100	02M-CGR1009 \$42.00	02M-CGO1109 \$42.00	02M-CBR1209 \$42.00	—	02M-CBK1409 \$42.00	02M-CBL1509 \$41.00	02M-CWH1609 \$41.00	—
Flat	1 x 4 x 50	02M-CGR1010 \$12.00	02M-CGO1110 \$12.00	—	—	02M-CBK1410 \$11.65	02M-CBL1510 \$11.25	—	—
Flat	1 x 2 x 100	02M-CGR1011 \$13.25	02M-CGO1111 \$13.25	02M-CBR1210 \$13.25	02M-COR1309 \$13.25	02M-CBK1411 \$13.25	02M-CBL1511 \$12.25	02M-CWH1610 \$12.25	02M-CRD1709 \$12.25
Flat	1 x 4 x 100	02M-CGR1012 \$21.00	02M-CGO1112 \$21.00	02M-CBR1211 \$21.00	02M-COR1310 \$21.00	02M-CBK1412 \$21.00	02M-CBL1512 \$20.00	02M-CWH1611 \$20.00	02M-CRD1710 \$20.00
Flat	1 x 6 x 100	02M-CGR1013 \$32.00	02M-CGO1113 \$32.00	02M-CBR1212 \$32.00	02M-COR1311 \$32.00	02M-CBK1413 \$32.00	02M-CBL1513 \$31.00	02M-CWH1612 \$31.00	02M-CRD1711 \$31.00
Flat	1 x 10 x 100	02M-CGR1014 \$41.50	02M-CGO1114 \$41.50	02M-CBR1213 \$41.50	02M-COR1312 \$41.50	02M-CBK1414 \$41.50	02M-CBL1514 \$40.00	02M-CWH1613 \$40.00	02M-CRD1712 \$40.00

QUANTITY DISCOUNTS
SUPER STONES 5+ OF SAME 10%

Ceramic Super Stones									
SHAPE	DIMENSIONS (MM)	GREEN (120 GRIT)	GOLD (180 GRIT)	LT. BROWN (300 GRIT)	ORANGE (400 GRIT)	BLACK (600 GRIT)	BLUE (800 GRIT)	WHITE (1000 GRIT)	RED (1200 GRIT)
Flat	1.5 x 4 x 100	02M-CGR1015 \$32.00	02M-CGO1115 \$32.00	02M-CBR1214 \$32.00	02M-COR1313 \$32.00	02M-CBK1415 \$32.00	02M-CBL1515 \$31.00	02M-CWH1614 \$31.00	02M-CRD1713 \$31.00
Flat	1.5 x 6 x 100	02M-CGR1016 \$47.50	02M-CGO1116 \$47.50	02M-CBR1215 \$47.50	02M-COR1314 \$47.50	02M-CBK1416 \$47.50	02M-CBL1516 \$46.50	—	—
Round	2.35 x 50	—	—	—	02M-COR1315 \$21.50	02M-CBK1417 \$21.50	02M-CBL1517 \$20.50	—	02M-CRD1714 \$20.50
Round	2.35 x 100	02M-CGR1017 \$42.50	02M-CGO1117 \$42.50	02M-CBR1216 \$42.50	—	02M-CBK1418 \$43.00	02M-CBL1518 \$41.00	—	02M-CRD1715 \$41.00
Round	3 x 50	02M-CGR1018 \$21.50	02M-CGO1118 \$21.50	02M-CBR1217 \$21.50	02M-COR1316 \$21.50	02M-CBK1419 \$21.50	02M-CBL1519 \$20.50	02M-CWH1615 \$20.50	02M-CRD1716 \$20.50
Round	3 x 100	02M-CGR1019 \$41.50	02M-CGO1119 \$41.50	02M-CBR1218 \$41.50	02M-COR1317 \$41.50	02M-CBK1420 \$41.50	02M-CBL1520 \$40.00	02M-CWH1616 \$40.00	02M-CRD1717 \$40.00
Round	3.16 x 50	02M-CGR1020 \$23.50	02M-CGO1120 \$23.50	02M-CBR1219 \$23.50	02M-COR1318 \$23.50	02M-CBK1421 \$23.50	02M-CBL1521 \$23.50	02M-CWH1617 \$23.50	02M-CRD1718 \$23.50

Miniature Ceramic Super Stones									
SHAPE	DIMENSIONS (MM)	GREEN (120 GRIT)	GOLD (180 GRIT)	LT. BROWN (300 GRIT)	ORANGE (400 GRIT)	BLACK (600 GRIT)	BLUE (800 GRIT)	WHITE (1000 GRIT)	RED (1200 GRIT)
Flat	0.5 x 0.5 x 50	02M-CGR1000 \$7.00	02M-CGO1100 \$7.00	02M-CBR1200 \$7.00	02M-COR1300 \$7.00	02M-CBK1400 \$7.00	02M-CBL1500 \$7.00	02M-CWH1600 \$7.00	02M-CRD1700 \$7.00
Flat	0.7 x 0.7 x 50	02M-CGR1001 \$7.00	02M-CGO1101 \$7.00	02M-CBR1201 \$7.00	02M-COR1301 \$7.00	02M-CBK1401 \$7.00	02M-CBL1501 \$7.00	02M-CWH1601 \$7.00	02M-CRD1701 \$7.00
Flat	0.9 x 0.9 x 50	02M-CGR1002 \$7.00	02M-CGO1102 \$7.00	02M-CBR1202 \$7.00	02M-COR1302 \$7.00	02M-CBK1402 \$7.00	02M-CBL1502 \$7.00	02M-CWH1602 \$7.00	02M-CRD1702 \$7.00
Flat	1.4 x 1.4 x 50	02M-CGR1003 \$7.00	02M-CGO1103 \$7.00	02M-CBR1203 \$7.00	02M-COR1303 \$7.00	02M-CBK1403 \$7.00	02M-CBL1503 \$7.00	02M-CWH1603 \$7.00	02M-CRD1703 \$7.00

QUANTITY DISCOUNTS
SUPER STONES 5+ OF SAME 10%



ADVANCING THE FUTURE OF DETAIL POLISHING WITH HIGH POLISHING EFFICIENCY AND INCREDIBLE BENDING STRENGTH
Cristone® Crystal Fiber Stones are made with the highest quality, chemically produced crystal fibers creating a crystalline structure that is perfect for detail polishing.

CUT AND POLISH IN ALL DIRECTIONS. EXCELLENT FOR USE IN RIBS, HARD-TO-REACH SLOTS AND SIDEWALLS.
Ceramic Diamond Stones are formulated with a combination of ceramic fibers and evenly distributed diamond particles to impart a continuous cutting action.

Cristone® Crystal Fiber Stones & Kits

Table with 8 columns: SHAPE, DIMENSIONS (MM), GREEN (150 GRIT), PINK (200 GRIT), VIOLET (400 GRIT), ORANGE (600 GRIT), BLUE (800 GRIT), WHITE (1000 GRIT). Rows include various shapes like Flat, Round and dimensions like 1 x 2 x 100, 1 x 4 x 100, etc.

Ceramic Diamond Stones

Table with 5 columns: SHAPE, DIMENSIONS (MM), BLACK (200 GRIT), BLUE (400 GRIT), GRAY (800 GRIT). Rows include Flat and Round shapes with dimensions like 1 x 4 x 100, 1 x 6 x 100, etc.

Ceramic Diamond Stone Sets

(Each set contains one piece of each stone)

Table with 4 columns: ORDER NO., DIMENSIONS (MM), GRITS, PRICE. Rows include 02Q-DKT9001 and 02Q-DKT9000.



QUANTITY DISCOUNTS CRISTONE CRYSTAL FIBER STONES 5+ SAME.....10%

Cristone® Crystal Fiber Stone Sets

(Each set contains one piece of each stone)

Table with 4 columns: ORDER NO., DIMENSIONS (MM), GRITS, PRICE. Rows include 02P-KKT9000 and 02P-KKT9001.

CNB-80 & CNB-120

Advanced Composite Provides Incredible Strength & Cutting Action. The CNB is an outstanding tool for blending welds and mold repairs.

PRODUCT FEATURES:

- Cuts the hardest tool steel
Extremely aggressive
Very coarse and fast cutting
Holds its shape
Consistent breakdown
CNB-120 fibers are 30% finer than CNB-80
Makes weld bead removal fast and seamless
Made in the USA

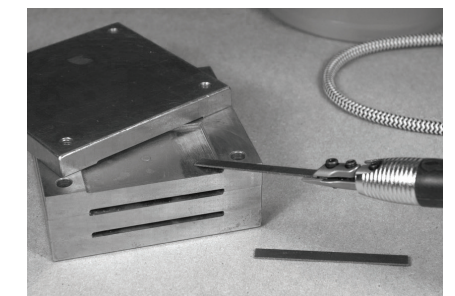

Table with 8 columns: SHAPE, DIMENSIONS (MM), CNB-80, PRICE, SHAPE, DIMENSIONS (MM), CNB-120, PRICE. Rows include Flat shapes with dimensions like 1.2 x 4 x 75, 1.2 x 6 x 75, etc.



Degussit Abrasive & Midget Files, Whetstones

WHY THEY'RE BETTER...

Falcon supplies the following kinds of ruby stones:

- Whetstones
• Abrasive Stones
• Midget Files

These stones are made from pure, synthetic, polycrystalline ruby; no bonding agents are ever used!

Because of their highly-sintered, bond-free, aluminum oxide structure, Falcon stones are the hardest of their kind available. Result? The performance advantages of these ruby stones and files are many:

- Great wear-resistance
• Even extremely hard materials are worked economically
• Machined parts are left with an outstanding finish
• Profile and edge stability are excellent

The Whetstones, Abrasive Stones and Midget Files are offered in extensive sizes and shapes; there's just the right one for each precision need.

SOME USES...

Ruby Stones are ideal hand tools for all kinds of sharpening, polishing, deburring and fine grinding. Here are some of their other uses:

- Sharpening any kind of tool
• Chamfering cutting tools
• Engraving profiles
• Working hardened steel and other hard and abrasive materials (quartz, glass, ceramics...)

Tool, die and mold makers use these Ruby Stones, Whetstones and Midget Files in the production of cutting, bending and pressing tools, as well as for sharpening and deburring.

Our Midget Files are especially designed for use in the finishing of holes, slots and formed parts.

SOME TIPS...

Ruby Stones and Files can be used wet or dry.

When "working wet," Falcon Stoning Oil makes an excellent moistening agent.

When "working dry," a cleaning rubber will remove all traces of the last job.

These tools are easily kept sharp by rubbing them with another Ruby Stone or file of the same or coarser type. A handlapper can be used to keep them sharp.

These Stones and Files are useful in many ways:

- Deburring • Chamfering
• Sharpening • Grinding
• Touching-up • Scaling

Degussit Abrasive Files

A pure, polycrystalline ruby, without bond

Table with 5 columns: STYLE NO., APPROX. DIMENSIONS, COARSE, MEDIUM, FINE

Three Square

Table with 5 columns: STYLE NO., APPROX. DIMENSIONS, COARSE, MEDIUM, FINE. Rows 200-203



Square

Table with 5 columns: STYLE NO., APPROX. DIMENSIONS, COARSE, MEDIUM, FINE. Rows 210-214



Degussit Abrasive Files

A pure, polycrystalline ruby, without bond

Table with 5 columns: STYLE NO., APPROX. DIMENSIONS, COARSE, MEDIUM, FINE

Flat

Table with 5 columns: STYLE NO., APPROX. DIMENSIONS, COARSE, MEDIUM, FINE. Rows 220-221



Half Round

Table with 5 columns: STYLE NO., APPROX. DIMENSIONS, COARSE, MEDIUM, FINE. Row 231



Diamond

Table with 5 columns: STYLE NO., APPROX. DIMENSIONS, COARSE, MEDIUM, FINE. Row 240



Round, One End Tapered

Table with 5 columns: STYLE NO., APPROX. DIMENSIONS, COARSE, MEDIUM, FINE. Row 255



Degussit Pencil

Table with 5 columns: STYLE NO., APPROX. DIMENSIONS, COARSE, MEDIUM, FINE. Row 261



Round

Table with 5 columns: STYLE NO., APPROX. DIMENSIONS, COARSE, MEDIUM, FINE. Rows 270-273



Knife

Table with 5 columns: STYLE NO., APPROX. DIMENSIONS, COARSE, MEDIUM, FINE. Row 291





Whetstones

A pure, polycrystalline ruby, without bond

Table with columns: STYLE NO., APPROX. DIMENSIONS, COARSE, MEDIUM, FINE. Rows for Rectangular styles 100 and 101.



Tapered

Table with columns: STYLE NO., APPROX. DIMENSIONS, COARSE, MEDIUM, FINE. Row for Tapered style 105.



Benchstones, cemented in wood case

Table with columns: STYLE NO., APPROX. DIMENSIONS, COARSE, MEDIUM, FINE. Rows for Benchstone styles 110 and 111.



Degussit Midget Files

One set Degussit Midget Files: 11 differently shaped files, one holder and 2 collets, fine grit

Table with columns: STYLE NO., ORDER NO., DIMENSIONS, PRICE. Lists 11 different file shapes and their prices.

Boron Carbide Hand Hone

For honing carbide and high speed steel tools

Table with columns: STYLE NO., ORDER NO., GRIT, PRICE. Lists two styles of Boron Carbide Hand Hone.

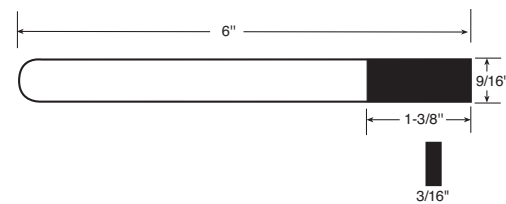

India Abrasive Files

India stones are made of aluminum oxide abrasive, brown in color. This abrasive is preferred for producing exceptionally keen, long lasting edges, and for high quality steel tool work.

Note: F indicates fine, M indicates medium, C indicates coarse.

India Stone Grit Chart

Table mapping grit numbers to file types: Fine (F) 320 Grit, Medium (M) 240 Grit, Coarse (C) 100 Grit.



India Square Files

Table with columns: STYLE NO., ORDER NO., SIZE (INCHES), PRICE EACH. Lists various square file styles and prices.



India Three Square Files

Table with columns: STYLE NO., ORDER NO., SIZE (INCHES), PRICE EACH. Lists various three-square file styles and prices.



India Taper Three Square Files

Table with columns: STYLE NO., ORDER NO., SIZE (INCHES), PRICE EACH. Lists taper three-square file styles and prices.



India Diamond Files

Table with columns: STYLE NO., ORDER NO., SIZE (INCHES), PRICE EACH. Lists diamond file styles and prices.



Note: F indicates fine, M indicates medium, C indicates coarse.

QUANTITY DISCOUNTS FOR ALL INDIA ABRASIVE FILES

20+ OF SAME.....15%



India Round Files

Table with 4 columns: STYLE NO., ORDER NO., SIZE (INCHES), PRICE EACH. Lists various round file styles and their prices.



India Half Round Files

Table with 4 columns: STYLE NO., ORDER NO., SIZE (INCHES), PRICE EACH. Lists various half round file styles and their prices.



India Taper Round Files

Table with 4 columns: STYLE NO., ORDER NO., SIZE (INCHES), PRICE EACH. Lists various taper round file styles and their prices.



India Points

Table with 4 columns: STYLE NO., ORDER NO., SIZE (INCHES), PRICE EACH. Lists various point file styles and their prices.



India Knife Blades

Table with 4 columns: STYLE NO., ORDER NO., SIZE (INCHES), PRICE EACH. Lists various knife blade styles and their prices.

India Silversmith's Stones

top view

side view



Table with 4 columns: STYLE NO., ORDER NO., SIZE (INCHES), PRICE EACH. Lists various India Silversmith's Stone styles and their prices.

Note: F indicates fine, M indicates medium, C indicates coarse.

QUANTITY DISCOUNTS FOR ALL INDIA ABRASIVE FILES

20+ OF SAME.....15%



India Bench Stones

STYLE NO.	ORDER NO.	SIZE (INCHES)	PRICE EACH
CB14	02K-IAF1939	4 x 1 x 1/4	\$6.16
MB14	02K-IAF1925	4 x 1 x 1/4	\$6.16
FB14	02K-IAF1934	4 x 1 x 1/4	\$6.16
CB24	02K-IAF1938	4 x 1 x 1/2	\$8.58
MB24	02K-IAF1926	4 x 1 x 1/2	\$8.58
FB24	02K-IAF1937	4 x 1 x 1/2	\$8.58
MB6	02K-IAF1936	6 x 2 x 1	\$19.86

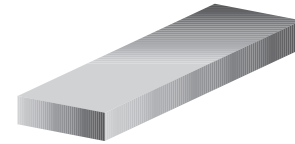

India Round Edge Slips

STYLE NO.	ORDER NO.	SIZE (INCHES)	PRICE EACH
MS24	02K-IAF1932	4-1/2 x 1-3/4 x 1/4 x 1/16	\$8.80
FS24	02K-IAF1933	4-1/2 x 1-3/4 x 1/4 x 1/16	\$8.80
MS44	02K-IAF1930	4-1/2 x 1-3/4 x 1/4 x 3/16	\$8.80
FS44	02K-IAF1927	4-1/2 x 1-3/4 x 1/4 x 3/16	\$8.80

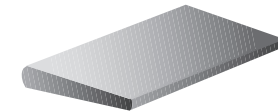

Crystolon Combination Stone

STYLE NO.	ORDER NO.	SIZE (INCHES)	PRICE EACH
JB64	02K-IAF1929	4 Dia. x 1	\$19.30

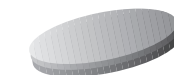

India Combination Stone

STYLE NO.	ORDER NO.	SIZE (INCHES)	PRICE EACH
IB64	02K-IAF1931	4 Dia. x 1	\$21.23
IB134	02K-IAF1935	4 x 1-3/4 x 5/8	\$13.26
IB6	02K-IAF1928	6 x 2 x 1	\$21.23

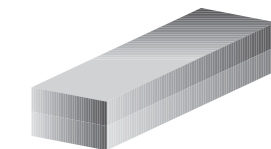

India Engravers Pencils

STYLE NO.	ORDER NO.	SIZE (INCHES)	PRICE EACH
IT17	02K-IAF2000	7" long x 1/8" Square Stone	\$8.70



India Reamer Stones

STYLE NO.	ORDER NO.	SIZE (INCHES)	PRICE EACH
MT124	02K-IAF1924	4-1/2 x 1 x 5/16	\$7.40

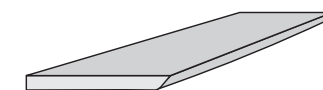

India Engravers Chucks

STYLE NO.	ORDER NO.	PRICE EACH
XT1	02K-IAF2100	\$16.10

India Stone Grit Chart

Fine (F)	320 Grit
Medium (M)	240 Grit
Coarse (C)	100 Grit

Arkansas Abrasive Files

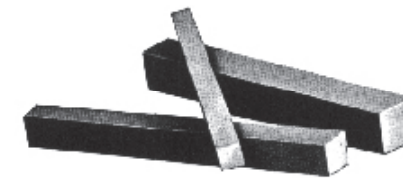

Arkansas Square Files

STYLE NO.	ORDER NO.	SIZE (INCHES)	PRICE EACH
HF13	02L-AAF1000	3-3-1/2 x 1/4	\$13.25
HF33	02L-AAF1001	3-3-1/2 x 3/8	\$14.20
HF43	02L-AAF1002	3-3-1/2 x 1/2	\$18.40



Hard Arkansas Pen Knife Pieces

SHAPE	STYLE NO.	ORDER NO.	SIZE (INCHES)	PRICE EACH
Pen Knife Piece	MT124	02L-AAF1207	4 x 1 x 1/4	\$27.50

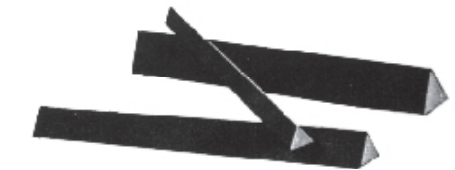

Arkansas Three Square Files

STYLE NO.	ORDER NO.	SIZE (INCHES)	PRICE EACH
HF113	02L-AAF1100	3-3-1/2 x 1/4	\$13.25
HF133	02L-AAF1101	3-3-1/2 x 3/8	\$14.20
HF143	02L-AAF1102	3-3-1/2 x 1/2	\$18.40



Arkansas Engravers Chucks & Points

SHAPE	STYLE NO.	ORDER NO.	SIZE (INCHES)	PRICE EACH
Pen Knife Piece	MT124	02L-AAF1207	4 x 1 x 1/4	\$27.50

Special Shaped Arkansas Files

SHAPE	STYLE NO.	ORDER NO.	SIZE (INCHES)	PRICE EACH	
	Round	HF813	02L-AAF1200	3-3-1/2 x 1/4-5/16	\$16.30
	Flat	HF823	02L-AAF1201	3-3-1/2 x 3/8-1/2 x 1/8-3/16	\$21.00
	Bevel	HF833	02L-AAF1220	3-3-1/2 x 3/8-1/2 x 1/8-3/16	\$13.70
	Diamond	HF843	02L-AAF1203	3-3-1/2 x 1/2 x 3/16-1/4	\$24.75
	Oval	HF853	02L-AAF1204	3-3-1/2 x 1/2 x 3/16-1/4	\$21.00
	Point	HF863	02L-AAF1205	3-3-1/2 x 1/4 Base	\$24.75
	Knife	HF873	02L-AAF1206	3-4 x 3/4-1 x 1/8-1/4	\$21.80

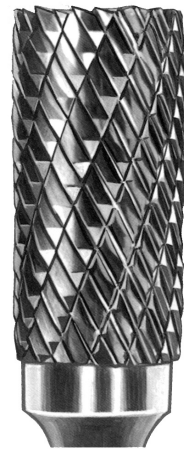

Falcon Solid Carbide Burs

- Full line for a wide range of applications
- Ferrous and Nonferrous configurations for excellent finishes and efficient stock removal
- Thirteen head shapes
- A wide selection of fluting styles
- Extra-long shanks available
- Miniature burs
- Automated, temperature-controlled brazing
- Machine-ground cutting flutes
- Tool-to-Tool consistency
- Lab inspected raw materials

BASIC FLUTING STYLES FOR CARBIDE BURS



DOUBLE CUT

Very efficient stock removal. Creates a small chip. Good finish. Excellent operator control.

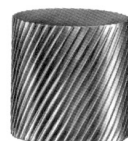

SINGLE CUT

General purpose fluting. Produces long chips.

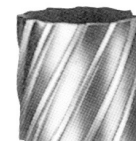

NONFERROUS

For nonferrous materials. Aggressive stock removal.



DIAMOND CUT

For heat treated and tough alloy steels where control is important. Creates a powder-like chip. Excellent finish.



COARSE CUT

Provides large flute area for softer ferrous materials. Fast stock removal.



FINE CUT

For general use on hard materials requiring a fine finish.

NOTE: Fine and Coarse cut styles are available in Double Cut and Single Cut. Double Cut supplied unless specified.

BUR SPEED RECOMMENDATIONS

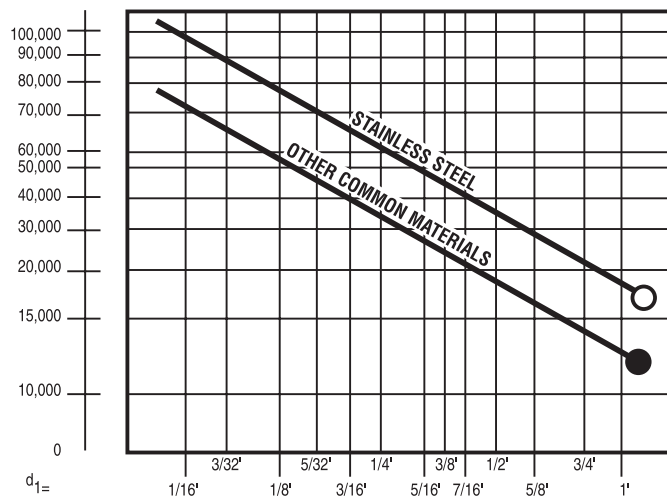

Regulation Safety Glasses should always be worn when using high-speed cutting equipment.

These are recommended speeds for standard length burs only. "Extra Long" burs with 1/4" shanks over 6" long and 1/8" shank burs over 2" long, should be used at reduced speeds. This chart should be considered a starting point, with possible variations to achieve optimum results.

Falcon Solid Carbide Burs

1/8" Shank • 1-1/2" Overall Length • Premium Quality • American Made
For Falcon Carbide Bur Sets, see page 36.
Always wear proper eye protection while using rotary power tool accessories.

QUANTITY DISCOUNTS

- 12 OF SAME.....5%
- 50 OF SAME.....10%
- 100 OF SAME.....15%



Shape No.	1	2*	3*	4*	5*	6*	7*
Cutter Diameter	1/16"	3/32"	1/8"	3/32"	1/8"	3/32"	1/8"
Flute Length	1/4"	7/16"	9/16"	7/16"	9/16"	3/32"	1/8"
Standard Double Cut	03A-BUR1000	03A-BUR1007	03A-BUR1014	03A-BUR1028	03A-BUR1035	03A-BUR1042	03A-BUR1049
Coarse Double Cut	03A-BUR1001	—	03A-BUR1015	03A-BUR1029	03A-BUR1036	03A-BUR1043	03A-BUR1050
Fine Double Cut	03A-BUR1002	03A-BUR1009	03A-BUR1016	03A-BUR1030	03A-BUR1037	03A-BUR1044	—
Standard Diamond Cut	03A-BUR1003	03A-BUR1010	—	03A-BUR1031	03A-BUR1038	03A-BUR1045	03A-BUR1052
Standard Single Cut	03A-BUR1004	03A-BUR1011	03A-BUR1018	03A-BUR1032	03A-BUR1039	03A-BUR1046	03A-BUR1053
Coarse Single Cut	03A-BUR1005	03A-BUR1012	03A-BUR1019	03A-BUR1033	03A-BUR1040	—	03A-BUR1054
Fine Single Cut	03A-BUR1006	03A-BUR1013	03A-BUR1020	03A-BUR1034	03A-BUR1041	03A-BUR1048	03A-BUR1055
Price for Std Double Cut or Std Single Cut	\$3.95	\$3.95	\$3.95	\$3.95	\$3.95	\$3.95	\$3.95

Price for All Other Cuts Based on Stock Availability	\$4.74	\$4.74	\$4.74	\$4.74	\$4.74	\$4.74	\$4.74
---	--------	--------	--------	--------	--------	--------	--------



Shape No.	8*	9	10*	11	12*	13*	14
Cutter Diameter	1/8"	1/8"	1/8"	1/8"	1/8"	1/8"	1/8"
Flute Length	7/32"	1/4"	1/2"	1/4"	1/2"	1/4"	3/32"
Standard Double Cut	03A-BUR1056	03A-BUR1063	03A-BUR1070	03A-BUR1077	03A-BUR1084	03A-BUR1091	03A-BUR1098
Coarse Double Cut	03A-BUR1057	—	03A-BUR1071	03A-BUR1078	03A-BUR1085	03A-BUR1092	03A-BUR1099
Fine Double Cut	—	03A-BUR1065	03A-BUR1072	03A-BUR1079	—	—	03A-BUR1100
Standard Diamond Cut	03A-BUR1059	03A-BUR1066	03A-BUR1073	03A-BUR1080	03A-BUR1087	03A-BUR1094	03A-BUR1101
Standard Single Cut	03A-BUR1060	03A-BUR1067	03A-BUR1074	03A-BUR1081	03A-BUR1088	03A-BUR1095	03A-BUR1102
Coarse Single Cut	03A-BUR1061	03A-BUR1068	03A-BUR1075	03A-BUR1082	03A-BUR1089	03A-BUR1096	03A-BUR1103
Fine Single Cut	03A-BUR1062	03A-BUR1069	03A-BUR1076	03A-BUR1083	03A-BUR1090	03A-BUR1097	03A-BUR1104
Price for Std Double Cut or Std Single Cut	\$3.95	\$3.95	\$3.95	\$3.95	\$3.95	\$3.95	\$3.95

Price for All Other Cuts Based on Stock Availability	\$4.74	\$4.74	\$4.74	\$4.74	\$4.74	\$4.74	\$4.74
---	--------	--------	--------	--------	--------	--------	--------

Falcon Solid Carbide Burs

1/8" Shank • 1-1/2" Overall Length • Premium Quality • American Made
 For Falcon Carbide Bur Sets, see page 36.
 Always wear proper eye protection while using rotary power tool accessories.

QUANTITY DISCOUNTS

12 OF SAME.....5%
 50 OF SAME.....10%
 100 OF SAME.....15%

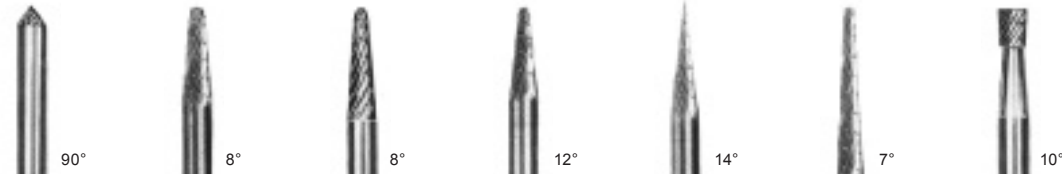

Shape No.	15	16	17	18*	19	20	21*
Cutter Diameter	1/8"	1/8"	1/8"	1/8"	1/8"	1/8"	1/8"
Flute Length	1/16"	3/8"	1/2"	11/32"	7/16"	5/8"	3/16"
Standard Double Cut	03A-BUR1105	03A-BUR1112	03A-BUR1119	03A-BUR1126	03A-BUR1133	03A-BUR1140	03A-BUR1147
Coarse Double Cut	03A-BUR1106	03A-BUR1113	03A-BUR1120	03A-BUR1127	03A-BUR1134	03A-BUR1141	03A-BUR1148
Fine Double Cut	03A-BUR1107	03A-BUR1114	03A-BUR1121	03A-BUR1128	03A-BUR1135	03A-BUR1142	03A-BUR1149
Standard Diamond Cut	03A-BUR1108	03A-BUR1115	03A-BUR1122	03A-BUR1129	03A-BUR1136	03A-BUR1143	03A-BUR1150
Standard Single Cut	03A-BUR1109	03A-BUR1116	03A-BUR1123	03A-BUR1130	03A-BUR1137	03A-BUR1144	03A-BUR1151
Coarse Single Cut	03A-BUR1110	03A-BUR1117	03A-BUR1124	03A-BUR1131	03A-BUR1138	03A-BUR1145	03A-BUR1152
Fine Single Cut	03A-BUR1111	03A-BUR1118	03A-BUR1125	03A-BUR1132	—	03A-BUR1146	03A-BUR1153
Price for Std Double Cut or Std Single Cut	\$3.95	\$3.95	\$3.95	\$3.95	\$3.95	\$3.95	\$3.95
Price for All Other Cuts Based on Stock Availability	\$4.74	\$4.74	\$4.74	\$4.74	\$4.74	\$4.74	\$4.74



Shape No.	101	101A	102	103	103A	104
Cutter Diameter	1/4"	3/16"	1/4"	1/4"	3/16"	1/4"
Flute Length	1/2"	1/2"	3/16"	1/2"	1/2"	1/4"
Standard Double Cut	03A-BUR1200	03A-BUR1207	03A-BUR1214	03A-BUR1228	03A-BUR1235	03A-BUR1242
Coarse Double Cut	03A-BUR1201	03A-BUR1208	03A-BUR1215	03A-BUR1229	03A-BUR1236	03A-BUR1243
Fine Double Cut	03A-BUR1202	03A-BUR1209	03A-BUR1216	03A-BUR1230	03A-BUR1237	03A-BUR1244
Standard Diamond Cut	03A-BUR1203	03A-BUR1210	03A-BUR1217*	03A-BUR1231	03A-BUR1238	03A-BUR1245
Standard Single Cut	03A-BUR1204	03A-BUR1211	03A-BUR1218	03A-BUR1232	03A-BUR1239	03A-BUR1246
Coarse Single Cut	03A-BUR1205	03A-BUR1212	—	03A-BUR1233	03A-BUR1240	03A-BUR1247
Fine Single Cut	03A-BUR1206	03A-BUR1213	03A-BUR1220	03A-BUR1234	03A-BUR1241	03A-BUR1248
Price for Std Double Cut or Std Single Cut	\$6.40	\$7.95	\$6.40	\$6.40	\$7.95	\$6.40
Price for All Other Cuts Based on Stock Availability	\$7.68	\$9.54	\$7.68 *\$8.94	\$7.68	\$9.54	\$7.68

Falcon Solid Carbide Burs

1/8" Shank • 3/16" and 1/4" Head • Premium Quality • American Made
 For Falcon Carbide Bur Sets, see page 36.
 Always wear proper eye protection while using rotary power tool accessories.

QUANTITY DISCOUNTS

12 OF SAME.....5%
 50 OF SAME.....10%
 100 OF SAME.....15%



Shape No.	104A	105	106	107	108	109
Cutter Diameter	3/16"	1/4"	1/4"	1/4"	1/4"	1/4"
Flute Length	3/16"	3/8"	1/2"	1/2"	1/2"	1/4"
Standard Double Cut	03A-BUR1249	03A-BUR1256	03A-BUR1263	03A-BUR1270	03A-BUR1277	03A-BUR1284
Coarse Double Cut	03A-BUR1250	03A-BUR1257	03A-BUR1264	03A-BUR1271	03A-BUR1278	03A-BUR1285
Fine Double Cut	03A-BUR1251	03A-BUR1258	03A-BUR1265	—	03A-BUR1279	03A-BUR1286
Standard Diamond Cut	03A-BUR1252	03A-BUR1259	03A-BUR1266	03A-BUR1273	03A-BUR1280	03A-BUR1287
Standard Single Cut	03A-BUR1253	03A-BUR1260	03A-BUR1267	03A-BUR1274	03A-BUR1281	03A-BUR1288
Coarse Single Cut	03A-BUR1254	03A-BUR1261	03A-BUR1268	03A-BUR1275	03A-BUR1282	—
Fine Single Cut	03A-BUR1255	03A-BUR1262	—	—	03A-BUR1283	03A-BUR1290
Price for Std Double Cut or Std Single Cut	\$7.95	\$6.40	\$6.40	\$6.40	\$6.40	\$6.40
Price for All Other Cuts Based on Stock Availability	\$9.54	\$7.68	\$7.68	\$7.68	\$7.68	\$7.68

End Cut Burs

Special End Cut 1/8" Shank
 End of Bur Is Single Cut

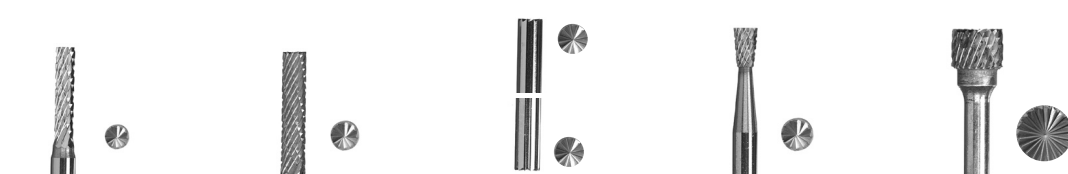

Shape No.	2	3	SB-ECO	21	102
Cutter Diameter	3/32"	1/8"	1/8"	1/8"	1/4"
Flute Length	7/16"	9/16"	End Only	3/16"	3/16"
Standard Double Cut	03A-BUR1155	03A-BUR1021	—	03A-BUR1156	03A-BUR1221
Coarse Double Cut	—	—	—	—	—
Fine Double Cut	—	—	—	—	—
Standard Diamond Cut	—	—	—	—	—
Standard Single Cut	—	03A-BUR1025	03A-BUR1157	—	03A-BUR1225
Coarse Single Cut	—	—	—	—	—
Fine Single Cut	—	—	—	—	—
Price for Std Double Cut or Std Single Cut	\$7.10	\$4.00	\$7.10	\$7.10	\$6.40
Price for All Other Cuts Based on Stock Availability	—	\$4.80	—	—	\$7.68

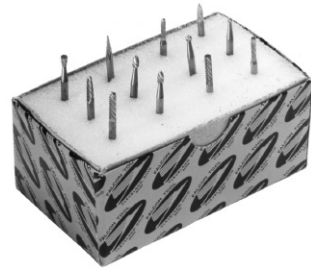

Set A • Falcon Solid Carbide Bur
1/8" Shank Diameter • 1-1/2" Overall Length • 12 Burs

1 each of bur 2, 3, 4, 5, 6, 7, 8, 10, 12, 13, 18, 21

Standard Double Cut	03A-BUR9000	\$42.60
Coarse Double Cut	—	—
Fine Double Cut	—	—
Standard Diamond Cut	—	—
Standard Single Cut	03A-BUR9004	\$42.60
Coarse Single Cut	—	—
Fine Single Cut	—	—

Price for All Other Cuts Based on Stock Availability



Set B • Falcon Solid Carbide Bur
1/8" Shank Diameter • 3/16" & 1/4" Head Diameter • 12 Burs

1 each of bur 101, 101A, 102, 103, 103A, 104, 104A, 105, 106, 107, 108, 109

Standard Double Cut	03A-BUR9100	\$74.90
Coarse Double Cut	—	—
Fine Double Cut	—	—
Standard Diamond Cut	—	—
Standard Single Cut	03A-BUR9104	\$74.90
Coarse Single Cut	—	—
Fine Single Cut	—	—

Price for All Other Cuts Based on Stock Availability



Set C • Falcon Solid Carbide Bur
1/4" Shank Diameter • 3/16" & 1/4" Head Diameter • 12 Burs

1 each of bur 1103, 1104, 1303, 1304, 1402, 1403, 1502, 1602, 1701, 2101, 2201, 2301

Standard Double Cut	03A-BUR9200	\$83.85
Coarse Double Cut	—	—
Fine Double Cut	—	—
Standard Diamond Cut	—	—
Standard Single Cut	03A-BUR9204	\$83.85
Coarse Single Cut	—	—
Fine Single Cut	—	—

Price for All Other Cuts Based on Stock Availability



Set D • Falcon Solid Carbide Bur
1/4" Shank Diameter • 3/8" Head Diameter • 10 Burs

1 each of bur 1106, 1306, 1405, 1503, 1603, 1703, 1902, 2002, 2204, 2302

Standard Double Cut	03A-BUR9300	\$98.90
Coarse Double Cut	—	—
Fine Double Cut	—	—
Standard Diamond Cut	—	—
Standard Single Cut	03A-BUR9304	\$98.90
Coarse Single Cut	—	—
Fine Single Cut	—	—

Price for All Other Cuts Based on Stock Availability

Falcon Solid Carbide Burs, 1/4" Shank

Always wear proper eye protection while using rotary power tool accessories.
For Falcon Carbide Bur Sets, see page 36.

QUANTITY DISCOUNTS

12 OF SAME.....	5%
50 OF SAME.....	10%
100 OF SAME.....	15%



Cylinder Shape

Shape No.	Cutter Dia.	Cut Length	Standard Double Cut	Coarse Double Cut	Fine Double Cut	Standard Diamond Cut	Standard Single Cut	Coarse Single Cut	Fine Single Cut	Price Std Single or Std Double Cut	Price for All Other Cuts
1101	1/8"	1/2"	03A-BUR1300	—	—	—	03A-BUR1304	—	—	\$7.25	\$8.70
1102	5/32"	5/8"	03A-BUR1307	—	—	—	03A-BUR1311	—	—	\$7.25	\$8.70
1103*	3/16"	5/8"	03A-BUR1314	03A-BUR1315	03A-BUR1316	03A-BUR1317	03A-BUR1318	03A-BUR1319	03A-BUR1320	\$7.25	\$8.70
1104*	1/4"	5/8"	03A-BUR1321	03A-BUR1322	03A-BUR1323	03A-BUR1324	03A-BUR1325	03A-BUR1326	—	\$7.50	\$9.00
1105	5/16"	3/4"	03A-BUR1328	—	—	—	03A-BUR1332	—	—	\$9.55	\$11.46
1106#	3/8"	3/4"	03A-BUR1335	03A-BUR1336	03A-BUR1337	03A-BUR1338	03A-BUR1339	03A-BUR1340	03A-BUR1341	\$10.30	\$12.36
1107	7/16"	1"	03A-BUR1342	—	—	—	03A-BUR1346	—	—	\$15.00	\$18.00
1108	1/2"	1"	03A-BUR1349	—	—	—	03A-BUR1353	—	—	\$16.10	\$19.32
1109	5/8"	1"	03A-BUR1356	—	—	—	03A-BUR1360	—	—	\$20.30	\$24.36
1110	3/4"	1"	03A-BUR1363	—	—	—	03A-BUR1367	—	—	\$30.25	\$36.30
1111	3/4"	1/2"	03A-BUR1370	—	—	—	03A-BUR1374	—	—	\$21.20	\$25.44
1112	3/4"	3/4"	03A-BUR1377	—	—	—	03A-BUR1381	—	—	\$23.85	\$28.62
1113	1"	1"	03A-BUR1384	—	—	—	03A-BUR1388	—	—	\$42.35	\$50.82

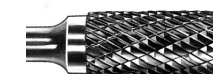

Cylinder Shape With End Cut

Shape No.	Cutter Dia.	Cut Length	Standard Double Cut	Coarse Double Cut	Fine Double Cut	Standard Diamond Cut	Standard Single Cut	Coarse Single Cut	Fine Single Cut	Price Std Single or Std Double Cut	Price for All Other Cuts
1201	1/8"	1/2"	03A-BUR1400	—	—	—	03A-BUR1404	—	—	\$8.00	\$9.60
1202	5/32"	5/8"	03A-BUR1407	—	—	—	03A-BUR1411	—	—	\$8.00	\$9.60
1203	3/16"	5/8"	03A-BUR1414	—	—	—	03A-BUR1418	—	—	\$8.00	\$9.60
1204	1/4"	5/8"	03A-BUR1421	—	03A-BUR1423	—	03A-BUR1425	—	—	\$8.25	\$9.90
1205	5/16"	3/4"	03A-BUR1428	—	—	—	03A-BUR1432	—	—	\$10.55	\$12.66
1206	3/8"	3/4"	03A-BUR1435	—	—	—	03A-BUR1439	—	—	\$11.35	\$13.62
1207	7/16"	1"	03A-BUR1442	—	—	—	03A-BUR1446	—	—	\$16.50	\$19.80
1208	1/2"	1"	03A-BUR1449	—	03A-BUR1451	—	03A-BUR1453	—	—	\$17.70	\$21.24
1209	5/8"	1"	03A-BUR1456	—	—	—	03A-BUR1460	—	—	\$22.35	\$26.82
1210	3/4"	1"	03A-BUR1463	—	—	—	03A-BUR1467	—	—	\$33.30	\$39.96
1211	3/4"	1/2"	03A-BUR1470	—	—	—	03A-BUR1474	—	—	\$23.30	\$27.96
1212	3/4"	3/4"	03A-BUR1477	—	—	—	03A-BUR1481	—	—	\$26.20	\$31.44
1213	1"	1"	03A-BUR1484	—	—	—	03A-BUR1488	—	—	\$46.60	\$55.92

Falcon Solid Carbide Burs, 1/4" Shank

Always wear proper eye protection while using rotary power tool accessories.
For Falcon Carbide Bur Sets, see page 36.

QUANTITY DISCOUNTS

12 OF SAME.....5%
50 OF SAME.....10%
100 OF SAME.....15%



Cylinder Shape With Radius End

Shape No.	Cutter Dia.	Cut Length	Standard Double Cut	Coarse Double Cut	Fine Double Cut	Standard Diamond Cut	Standard Single Cut	Coarse Single Cut	Fine Single Cut	Price Std Single or Std Double Cut	Price for All Other Cuts
1301	1/8"	1/2"	03A-BUR1500	--	--	--	03A-BUR1504	--	--	\$8.45	\$10.14
1302	5/32"	5/8"	03A-BUR1507	--	--	--	03A-BUR1511	--	--	\$8.45	\$10.14
1303*	3/16"	5/8"	03A-BUR1514	03A-BUR1515	03A-BUR1516	03A-BUR1517	03A-BUR1518	03A-BUR1519	03A-BUR1520	\$8.45	\$10.14
1304*	1/4"	5/8"	03A-BUR1521	03A-BUR1522	03A-BUR1523	03A-BUR1524	03A-BUR1525	03A-BUR1526	03A-BUR1527	\$8.70	\$10.44
1305	5/16"	3/4"	03A-BUR1528	--	--	--	03A-BUR1532	--	--	\$10.55	\$12.60
1306#	3/8"	3/4"	03A-BUR1535	03A-BUR1536	03A-BUR1537	03A-BUR1538	03A-BUR1539	03A-BUR1540	03A-BUR1541	\$11.50	\$13.80
1307	7/16"	1"	03A-BUR1542	--	--	--	03A-BUR1546	--	--	\$16.45	\$19.74
1308	1/2"	1"	03A-BUR1549	--	--	--	03A-BUR1553	--	--	\$18.05	\$21.66
1309	5/8"	1"	03A-BUR1556	--	--	--	03A-BUR1560	--	--	\$22.75	\$27.30
1310	3/4"	1"	03A-BUR1563	--	--	--	03A-BUR1567	--	--	\$32.65	\$39.18
1313	1"	1"	03A-BUR1570	--	--	--	03A-BUR1574	--	--	\$49.60	\$59.52



Ball Shape

Shape No.	Cutter Dia.	Cut Length	Standard Double Cut	Coarse Double Cut	Fine Double Cut	Standard Diamond Cut	Standard Single Cut	Coarse Single Cut	Fine Single Cut	Price Std Single or Std Double Cut	Price for All Other Cuts
1401	1/8"	3/32"	03A-BUR1600	--	--	--	03A-BUR1604	--	--	\$7.65	\$9.18
1402*	3/16"	1/8"	03A-BUR1607	03A-BUR1608	03A-BUR1609	03A-BUR1610	03A-BUR1611	03A-BUR1612	03A-BUR1613	\$7.65	\$9.18
1403*	1/4"	3/16"	03A-BUR1614	03A-BUR1615	03A-BUR1616	--	03A-BUR1618	03A-BUR1619	03A-BUR1620	\$7.65	\$9.18
1404	5/16"	1/4"	03A-BUR1621	--	--	--	03A-BUR1625	--	--	\$8.40	\$10.08
1405#	3/8"	5/16"	03A-BUR1628	03A-BUR1629	03A-BUR1630	03A-BUR1631	03A-BUR1632	03A-BUR1633	03A-BUR1634	\$9.45	\$11.34
1406	7/16"	3/8"	03A-BUR1635	--	--	--	03A-BUR1639	--	--	\$10.90	\$13.08
1407	1/2"	7/16"	03A-BUR1642	--	--	--	03A-BUR1646	--	--	\$12.70	\$15.24
1408	5/8"	9/16"	03A-BUR1649	--	03A-BUR1651	--	03A-BUR1653	--	--	\$15.75	\$18.90
1409	3/4"	11/16"	03A-BUR1656	--	--	--	03A-BUR1660	--	--	\$21.80	\$26.16
1410	1"	15/16"	03A-BUR1663	--	--	--	03A-BUR1667	--	--	\$37.50	\$45.00

Falcon Solid Carbide Burs, 1/4" Shank

Always wear proper eye protection while using rotary power tool accessories.
For Falcon Carbide Bur Sets, see page 36.

QUANTITY DISCOUNTS

12 OF SAME.....5%
50 OF SAME.....10%
100 OF SAME.....15%



Oval Shape

Shape No.	Cutter Dia.	Cut Length	Standard Double Cut	Coarse Double Cut	Fine Double Cut	Standard Diamond Cut	Standard Single Cut	Coarse Single Cut	Fine Single Cut	Price Std Single or Std Double Cut	Price for All Other Cuts
1501	3/16"	5/16"	03A-BUR1700	03A-BUR1701	--	--	03A-BUR1704	--	--	\$8.35	\$10.02
1502*	1/4"	3/8"	03A-BUR1707	03A-BUR1708	03A-BUR1709	03A-BUR1710	03A-BUR1711	03A-BUR1712	03A-BUR1713	\$9.55	\$11.46
1503#	3/8"	5/8"	03A-BUR1714	03A-BUR1715	03A-BUR1716	03A-BUR1717	03A-BUR1718	03A-BUR1719	03A-BUR1720	\$11.50	\$13.80
1504	1/2"	7/8"	03A-BUR1721	--	--	--	03A-BUR1725	--	--	\$16.85	\$20.22
1505	5/8"	1"	03A-BUR1728	--	--	--	03A-BUR1732	--	--	\$23.40	\$28.08
1506	3/4"	1"	03A-BUR1735	--	--	--	03A-BUR1739	--	--	\$31.45	\$37.74



Flame Shape

Shape No.	Cutter Dia.	Cut Length	Standard Double Cut	Coarse Double Cut	Fine Double Cut	Standard Diamond Cut	Standard Single Cut	Coarse Single Cut	Fine Single Cut	Price Std Single or Std Double Cut	Price for All Other Cuts
1804	5/16"	3/4"	03A-BUR2000	--	--	--	03A-BUR2004	--	--	\$11.85	\$14.22
1805	1/2"	1-1/4"	03A-BUR2007	--	--	--	03A-BUR2011	--	--	\$24.10	\$28.92
1806	5/8"	1-7/16"	03A-BUR2014	--	--	--	03A-BUR2018	--	--	\$33.30	\$39.96
1807	3/4"	1-5/8"	03A-BUR2021	--	--	--	03A-BUR2025	--	--	\$59.04	\$50.82



Tree Shape With Radius End

Shape No.	Cutter Dia.	Cut Length	Standard Double Cut	Coarse Double Cut	Fine Double Cut	Standard Diamond Cut	Standard Single Cut	Coarse Single Cut	Fine Single Cut	Price Std Single or Std Double Cut	Price for All Other Cuts
1601	1/8"	1/2"	03A-BUR1800	--	--	--	03A-BUR1804	--	--	\$8.85	\$10.62
1602*	1/4"	5/8"	03A-BUR1807	03A-BUR1808	03A-BUR1809	03A-BUR1810	03A-BUR1811	03A-BUR1812	03A-BUR1813	\$8.85	\$10.62
1603#	3/8"	3/4"	03A-BUR1814	03A-BUR1815	--	03A-BUR1817	03A-BUR1818	03A-BUR1819	03A-BUR1820	\$11.30	\$13.56
1605	1/2"	1"	03A-BUR1821	--	--	--	03A-BUR1825	--	--	\$16.60	\$19.92
1606	1/2"	3/4"	03A-BUR1828	--	--	--	03A-BUR1832	--	--	\$15.60	\$18.72
1607	5/8"	1"	03A-BUR1835	--	--	--	03A-BUR1839	--	--	\$23.00	\$27.60
1608	3/4"	1"	03A-BUR1842	--	--	--	03A-BUR1846	--	--	\$30.25	\$36.30
1609	3/4"	1-1/4"	03A-BUR1849	--	--	--	03A-BUR1853	--	--	\$38.10	\$45.72
1610	3/4"	1-1/2"	03A-BUR1856	--	--	--	03A-BUR1860	--	--	\$44.75	\$53.70

Falcon Solid Carbide Burs, 1/4" Shank

Always wear proper eye protection while using rotary power tool accessories.
For Falcon Carbide Bur Sets, see page 36.

QUANTITY DISCOUNTS

12 OF SAME.....5%
50 OF SAME.....10%
100 OF SAME.....15%



Tree Shape With Pointed End

Shape No.	Cutter Dia.	Cut Length	Standard Double Cut	Coarse Double Cut	Fine Double Cut	Standard Diamond Cut	Standard Single Cut	Coarse Single Cut	Fine Single Cut	Price Std Single or Std Double Cut	Price for All Other Cuts
1701*	1/4"	5/8"	03A-BUR1900	03A-BUR1901	03A-BUR1902	—	03A-BUR1904	03A-BUR1905	03A-BUR1906	\$8.85	\$10.62
1702	5/16"	5/8"	03A-BUR1907	—	03A-BUR1909	—	03A-BUR1911	—	03A-BUR1913	\$10.80	\$12.96
1703#	3/8"	3/4"	03A-BUR1914	03A-BUR1915	—	03A-BUR1917	03A-BUR1918	03A-BUR1919	—	\$12.00	\$14.40
1704	1/2"	1"	03A-BUR1921	—	—	—	03A-BUR1925	—	—	\$16.35	\$19.62
1705	1/2"	3/4"	03A-BUR1928	—	—	—	03A-BUR1932	—	—	\$15.15	\$18.18
1706	5/8"	1"	03A-BUR1935	—	—	—	03A-BUR1939	—	—	\$22.70	\$27.24
1707	3/4"	1"	03A-BUR1942	—	—	—	03A-BUR1946	—	—	\$30.25	\$36.30
1708	3/4"	1-1/2"	03A-BUR1949	—	—	—	03A-BUR1953	—	—	\$44.75	\$53.70



60° Cone Shape

Shape No.	Cutter Dia.	Cut Length	Standard Double Cut	Coarse Double Cut	Fine Double Cut	Standard Diamond Cut	Standard Single Cut	Coarse Single Cut	Fine Single Cut	Price Std Single or Std Double Cut	Price for All Other Cuts
1901	1/4"	3/16"	03A-BUR2100	—	—	—	03A-BUR2104	—	—	\$7.85	\$9.42
1902#	3/8"	5/16"	03A-BUR2107	03A-BUR2108	03A-BUR2109	03A-BUR2110	03A-BUR2111	03A-BUR2112	03A-BUR2113	\$10.20	\$12.24
1903	1/2"	7/16"	03A-BUR2114	—	—	—	03A-BUR2118	—	—	\$12.50	\$15.00
1904	5/8"	9/16"	03A-BUR2121	—	—	—	03A-BUR2125	—	—	\$16.60	\$19.92
1905	3/4"	11/16"	03A-BUR2128	—	—	—	03A-BUR2132	—	—	\$21.90	\$26.28
1906	1"	15/16"	03A-BUR2135	—	—	—	03A-BUR2139	—	—	\$35.10	\$42.12



90° Cone Shape

Shape No.	Cutter Dia.	Cut Length	Standard Double Cut	Coarse Double Cut	Fine Double Cut	Standard Diamond Cut	Standard Single Cut	Coarse Single Cut	Fine Single Cut	Price Std Single or Std Double Cut	Price for All Other Cuts
2001	1/4"	1/8"	03A-BUR2200	—	03A-BUR2202	—	03A-BUR2204	—	—	\$7.65	\$9.18
2002#	3/8"	3/16"	03A-BUR2207	03A-BUR2208	03A-BUR2209	03A-BUR2210	03A-BUR2211	03A-BUR2212	03A-BUR2213	\$10.00	\$12.00
2003	1/2"	1/4"	03A-BUR2214	—	—	—	03A-BUR2218	—	—	\$12.50	\$15.00
2004	5/8"	5/16"	03A-BUR2221	—	03A-BUR2223	—	03A-BUR2225	—	—	\$16.35	\$19.62
2005	3/4"	3/8"	03A-BUR2228	—	—	—	03A-BUR2232	—	—	\$21.90	\$26.28
2006	1"	1/2"	03A-BUR2235	—	—	—	03A-BUR2239	—	—	\$35.10	\$42.12

Falcon Solid Carbide Burs, 1/4" Shank

Always wear proper eye protection while using rotary power tool accessories.
For Falcon Carbide Bur Sets, see page 36.

QUANTITY DISCOUNTS

12 OF SAME.....5%
50 OF SAME.....10%
100 OF SAME.....15%



14° Taper With Radius End

Shape No.	Cutter Dia.	Cut Length	Standard Double Cut	Coarse Double Cut	Fine Double Cut	Standard Diamond Cut	Standard Single Cut	Coarse Single Cut	Fine Single Cut	Price Std Single or Std Double Cut	Price for All Other Cuts
2101*	1/4"	5/8"	03A-BUR2300	03A-BUR2301	03A-BUR2302	03A-BUR2303	03A-BUR2304	03A-BUR2305	03A-BUR2306	\$9.10	\$10.92
2102	5/16"	7/8"	03A-BUR2307	—	—	—	03A-BUR2311	—	—	\$12.00	\$14.40
2103	3/8"	1-1/16"	03A-BUR2314	—	—	—	03A-BUR2318	—	—	\$14.35	\$17.22
2104	1/2"	1-1/8"	03A-BUR2321	—	—	—	03A-BUR2325	—	—	\$17.55	\$21.06
2105	5/8"	1-3/16"	03A-BUR2328	—	—	—	03A-BUR2332	—	—	\$31.45	\$37.74
2106	3/4"	1-1/2"	03A-BUR2335	—	—	—	03A-BUR2339	—	—	\$45.70	\$54.84



Cone Shape

Shape No.	Cutter Dia.	Cut Length	Inc'l Angle	Standard Double Cut	Coarse Double Cut	Fine Double Cut	Standard Diamond Cut	Standard Single Cut	Coarse Single Cut	Fine Single Cut	Price Std Single or Std Double Cut	Price for All Other Cuts
2201*	1/4"	1/2"	22°	03A-BUR2400	03A-BUR2401	03A-BUR2402	03A-BUR2403	03A-BUR2404	03A-BUR2405	03A-BUR2406	\$8.35	\$10.02
2202	1/4"	3/4"	14°	03A-BUR2407	—	—	—	03A-BUR2411	—	—	\$9.10	\$10.92
2203	1/4"	1"	10°	03A-BUR2414	—	—	—	03A-BUR2418	—	—	\$9.70	\$11.64
2204#	3/8"	5/8"	28°	03A-BUR2421	03A-BUR2422	03A-BUR2423	—	03A-BUR2425	03A-BUR2426	03A-BUR2427	\$14.40	\$17.28
2205	1/2"	7/8"	28°	03A-BUR2428	—	—	—	03A-BUR2432	—	—	\$18.05	\$21.66
2206	5/8"	1"	31°	03A-BUR2435	—	—	—	03A-BUR2439	—	—	\$24.10	\$28.92



Inverted Cone Shape

Shape No.	Cutter Dia.	Cut Length	Inc'l Angle	Standard Double Cut	Coarse Double Cut	Fine Double Cut	Standard Diamond Cut	Standard Single Cut	Coarse Single Cut	Fine Single Cut	Price Std Single or Std Double Cut	Price for All Other Cuts
2301*	1/4"	5/16"	10°	03A-BUR2500	03A-BUR2501	03A-BUR2502	03A-BUR2503	03A-BUR2504	—	03A-BUR2506	\$8.70	\$10.44
2302#	3/8"	3/8"	13°	03A-BUR2507	03A-BUR2508	—	03A-BUR2510	03A-BUR2511	03A-BUR2512	—	\$12.70	\$15.24
2303	1/2"	1/2"	28°	03A-BUR2514	—	—	—	03A-BUR2518	—	03A-BUR2520	\$17.95	\$21.54
2304	5/8"	3/4"	18°	03A-BUR2521	—	—	—	03A-BUR2525	—	—	\$23.10	\$27.72
2305	3/4"	5/8"	30°	03A-BUR2528	—	—	—	03A-BUR2532	—	—	\$26.00	\$31.20

Falcon Solid Carbide Burs, 1/8" Shank

2" Overall Length • 3" Overall Length • Premium Quality • American Made

2" Overall Length

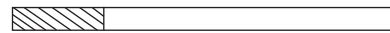

3" Overall Length

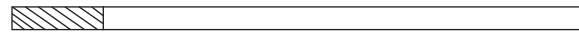

Shape No.	1	2	3	4	5	6	PRICE
Cutter Diameter	1/16"	3/32"	1/8"	1/8"	1/8"	1/8"	
Flute Length	1/4"	7/16"	9/16"	9/16"	9/16"	1/8"	
2" OAL Double Cut	03A-BUR2701	03A-BUR2702	03A-BUR2703	03A-BUR2704	03A-BUR2705	03A-BUR2706	\$9.80 each
2" OAL Single Cut	03A-BUR2713	03A-BUR2714	03A-BUR2715	03A-BUR2716	03A-BUR2717	03A-BUR2718	\$9.80 each
3" OAL Double Cut	03A-BUR2725	03A-BUR2726	03A-BUR2727	03A-BUR2728	03A-BUR2729	03A-BUR2730	\$11.10 each
3" OAL Single Cut	03A-BUR2737	03A-BUR2738	03A-BUR2739	03A-BUR2740	03A-BUR2741	03A-BUR2742	\$11.10 each



Shape No:	8	10	12	13	17	19	PRICE
Cutter Diameter	1/8"	1/8"	1/8"	1/8"	1/8"	1/8"	
Flute Length	7/32"	1/2"	1/2"	1/4"	1/2"	7/16"	
2" OAL Double Cut	03A-BUR2707	03A-BUR2708	03A-BUR2709	03A-BUR2710	03A-BUR2711	03A-BUR2712	\$9.80 each
2" OAL Single Cut	03A-BUR2719	03A-BUR2720	03A-BUR2721	03A-BUR2722	03A-BUR2723	03A-BUR2724	\$9.80 each
3" OAL Double Cut	03A-BUR2731	03A-BUR2732	03A-BUR2733	03A-BUR2734	03A-BUR2735	03A-BUR2736	\$11.10 each
3" OAL Single Cut	03A-BUR2743	03A-BUR2744	03A-BUR2745	03A-BUR2746	03A-BUR2747	03A-BUR2748	\$11.10 each

QUANTITY DISCOUNTS

12 OF SAME.....	5%
50 OF SAME.....	10%
100 OF SAME.....	15%

Falcon Long Shank Carbide Burs, 1/4" x 6" Shank

- All burs are provided with 6" long steel shanks
- Long shank carbide burs solve tough, hard-to-reach deburring jobs
- Steel shank can be easily shortened by hacksaw
- Always wear proper eye protection while using rotary power tool accessories



Cylinder Shape

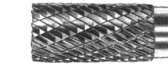

SHAPE NO.	CUTTER DIA.	CUT LENGTH	STANDARD DOUBLE CUT	STANDARD SINGLE CUT	PRICE EACH
SA-1L6	1/4"	1/2"	03A-BUR2601	03A-BUR2624	\$16.90
SA-3L6	3/8"	3/4"	03A-BUR2602	03A-BUR2625	\$23.85
SA-5L6	1/2"	1"	03A-BUR2603	03A-BUR2626	\$37.19

Cylinder Shape Radius End



SHAPE NO.	CUTTER DIA.	CUT LENGTH	STANDARD DOUBLE CUT	STANDARD SINGLE CUT	PRICE EACH
SA-1L6	1/4"	1/2"	03A-BUR2604	03A-BUR2627	\$19.70
SA-3L6	3/8"	3/4"	03A-BUR2605	03A-BUR2628	\$26.53
SA-5L6	1/2"	1"	03A-BUR2606	03A-BUR2629	\$41.71

Ball Shape

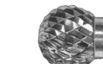

SHAPE NO.	CUTTER DIA.	CUT LENGTH	STANDARD DOUBLE CUT	STANDARD SINGLE CUT	PRICE EACH
SA-1L6	1/4"	7/32"	03A-BUR2607	03A-BUR2630	\$18.19
SA-3L6	3/8"	5/16"	03A-BUR2608	03A-BUR2631	\$21.82
SA-5L6	1/2"	7/16"	03A-BUR2609	03A-BUR2632	\$29.39

Oval Shape

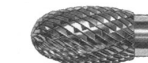

SHAPE NO.	CUTTER DIA.	CUT LENGTH	STANDARD DOUBLE CUT	STANDARD SINGLE CUT	PRICE EACH
SE-1L6	1/4"	3/8"	03A-BUR2610	03A-BUR2633	\$21.90
SE-3L6	3/8"	5/8"	03A-BUR2611	03A-BUR2634	\$26.53
SE-5L6	1/2"	7/8"	03A-BUR2612	03A-BUR2635	\$38.85

QUANTITY DISCOUNTS

12 OF SAME.....	5%
50 OF SAME.....	10%
100 OF SAME.....	15%

Tree Shape Radius End

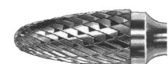

SHAPE NO.	CUTTER DIA.	CUT LENGTH	STANDARD DOUBLE CUT	STANDARD SINGLE CUT	PRICE EACH
SA-1L6	1/4"	1/2"	03A-BUR2613	03A-BUR2636	\$20.56
SA-3L6	3/8"	3/4"	03A-BUR2614	03A-BUR2637	\$26.00
SA-5L6	1/2"	1"	03A-BUR2615	03A-BUR2638	\$38.32

Tree Shape Pointed End

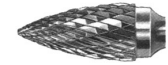

SHAPE NO.	CUTTER DIA.	CUT LENGTH	STANDARD DOUBLE CUT	STANDARD SINGLE CUT	PRICE EACH
SA-1L6	1/4"	1/2"	03A-BUR2616	03A-BUR2639	\$20.56
SA-3L6	3/8"	3/4"	03A-BUR2617	03A-BUR2640	\$27.66
SA-5L6	1/2"	1"	03A-BUR2618	03A-BUR2641	\$37.78

Flame Shape

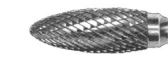

SHAPE NO.	CUTTER DIA.	CUT LENGTH	STANDARD DOUBLE CUT	STANDARD SINGLE CUT	PRICE EACH
SH-2L6	5/16"	3/4"	03A-BUR2619	03A-BUR2642	\$27.29
SH-5L6	1/2"	1-1/4"	03A-BUR2620	03A-BUR2643	\$55.55

14° Taper Radius End



SHAPE NO.	CUTTER DIA.	CUT LENGTH	STANDARD DOUBLE CUT	STANDARD SINGLE CUT	PRICE EACH
SE-1L6	1/4"	5/8"	03A-BUR2621	03A-BUR2644	\$21.04
SE-3L6	3/8"	1-1/16"	03A-BUR2622	03A-BUR2645	\$33.16
SE-4L6	1/2"	1-1/8"	03A-BUR2623	03A-BUR2646	\$40.58

Falcon Midget Carbide Burs, 3/32" Shank Super Carbide Burs

MATERIAL: High performance Carbide of the best grade.

WORKMANSHIP: Special process assures a strong bond between Carbide and steel, not affected by temperature. Exact concentricity. Unusual durability, resistant to wear, even under unfavorable conditions.

APPLICATION: Leverage and planing motion must be avoided to prevent breakage. Use only with true running handpieces and chucks. Instruments with heavier shaft will afford greater safety. Not recommended for use above 120,000 rpm.









QUANTITY DISCOUNTS

72 PIECES OF SAME.....5%
144 PIECES OF SAME.....10%

Midget Burs are approximately 1-3/4" overall length.

Round

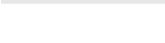

SHAPE	SHAPE NO.	ORDER NO.	ISO NO.	DIA.	PRICE
	1/2	03B-MCB1000	007	.028"	\$3.35
	1	03B-MCB1001	008	.031"	\$3.35
	2	03B-MCB1002	010	.039"	\$3.35
	3	03B-MCB1003	012	.047"	\$3.35
	4	03B-MCB1004	014	.055"	\$3.35
	5	03B-MCB1005	016	.063"	\$3.35
	6	03B-MCB1006	018	.071"	\$3.35
	8	03B-MCB1007	023	.091"	\$3.35
	10	03B-MCB1008	027	.106"	\$10.60







Wheel

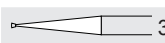

SHAPE	SHAPE NO.	ORDER NO.	ISO NO.	DIA.	PRICE
	14	03B-MCB1009	012	.047"	\$3.35

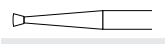

Inverted Cone



SHAPE	SHAPE NO.	ORDER NO.	ISO NO.	DIA.	PRICE
	33-1/2	03B-MCB1010	007	.028"	\$3.35
	34	03B-MCB1011	008	.031"	\$3.35
	35	03B-MCB1012	010	.039"	\$3.35
	36	03B-MCB1013	012	.047"	\$3.35
	37	03B-MCB1014	014	.055"	\$3.35
	38	03B-MCB1015	016	.063"	\$3.35
	39	03B-MCB1016	018	.071"	\$3.35

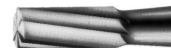

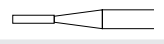
Cylinder Square Single Cut



SHAPE	SHAPE NO.	ORDER NO.	ISO NO.	DIA.	PRICE
	56	03B-MCB1017	009	.035"	\$3.35
	57	03B-MCB1018	010	.039"	\$3.35
	58	03B-MCB1019	012	.047"	\$3.35
	59	03B-MCB1020	016	.063"	\$3.35



Universal Single Cut



SHAPE	SHAPE NO.	ORDER NO.	ISO NO.	DIA.	PRICE
	57U	03B-MCB1021	010	.039"	\$3.65
	58U	03B-MCB1022	012	.047"	\$3.65

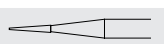

Cone Square Taper • Single Cut

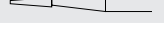

SHAPE	SHAPE NO.	ORDER NO.	ISO NO.	DIA.	PRICE
	169	03B-MCB1023	008	.031"	\$3.35
	170	03B-MCB1024	010	.039"	\$3.35
	171	03B-MCB1025	014	.055"	\$3.35

Universal Taper • Single Cut

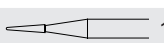

SHAPE	SHAPE NO.	ORDER NO.	ISO NO.	DIA.	PRICE
	170U	03B-MCB1026	010	.039"	\$3.65
	171U	03B-MCB1027	014	.055"	\$3.65

Falcon Midget Carbide Burs, 3/32" Shank Super Carbide Burs





Midget Burs are approximately 1-3/4" overall length.

QUANTITY DISCOUNTS

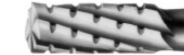
72 PIECES OF SAME.....5%
144 PIECES OF SAME.....10%

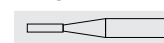
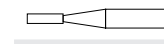



Cylinder Square Cross Cut



SHAPE	SHAPE NO.	ORDER NO.	ISO NO.	DIA.	PRICE
	557	03B-MCB1028	010	.039"	\$3.35
	558	03B-MCB1029	012	.047"	\$3.35
	559	03B-MCB1030	014	.055"	\$3.35
	560	03B-MCB1031	016	.063"	\$3.35
	561	03B-MCB1032	018	.071"	\$3.35

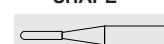



Universal Cross Cut



SHAPE	SHAPE NO.	ORDER NO.	ISO NO.	DIA.	PRICE
	557U	03B-MCB1033	010	.039"	\$3.65
	558U	03B-MCB1034	012	.047"	\$3.65
	559U	03B-MCB1035	014	.055"	\$3.65
	560U	03B-MCB1036	016	.063"	\$3.65
	561U	03B-MCB1037	018	.071"	\$3.65

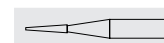
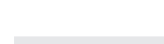



Cone Square Taper • Cross Cut

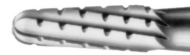

SHAPE	SHAPE NO.	ORDER NO.	ISO NO.	DIA.	PRICE
	700	03B-MCB1038	010	.039"	\$3.35
	701 SP	03B-MCB1048	012	.047"	\$3.35
	701	03B-MCB1039	014	.055"	\$3.35
	702	03B-MCB1040	016	.063"	\$3.35
	703	03B-MCB1041	018	.071"	\$3.35

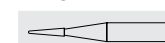
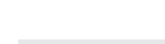
Universal Taper • Cross Cut

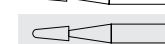

SHAPE	SHAPE NO.	ORDER NO.	ISO NO.	DIA.	PRICE
	700U	03B-MCB1042	010	.039"	\$3.65
	701U SP	03B-MCB1049	012	.047"	\$3.65
	701U	03B-MCB1043	014	.055"	\$3.65
	702U	03B-MCB1044	016	.063"	\$3.65
	703U	03B-MCB1045	018	.071"	\$3.65

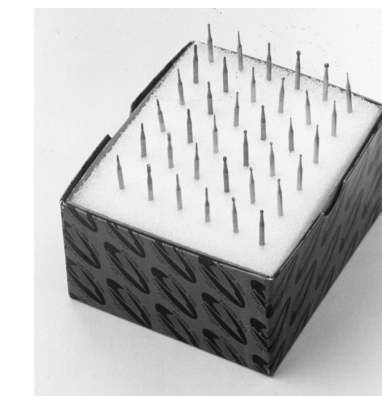

MIDGET CARBIDE SET
Assorted set of 36 pieces

ORDER NO. 03B-MCB9000
\$127.75



Falcon Carbide Cylinders & Split Blanks

Cylinders / Grade C2

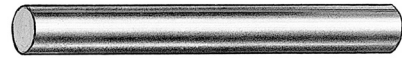

Table with 3 columns: SIZE INCHES, ORDER NO., PRICE PER PIECE. Lists various cylinder sizes and prices for Grade C2.

"A" - Split One End / Grade C2

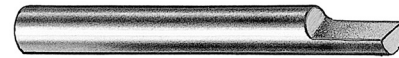

Table with 3 columns: SIZE INCHES, ORDER NO., PRICE PER PIECE. Lists split cylinder sizes and prices for Grade C2.

"B" - Split Both Ends / Grade C2



Table with 3 columns: SIZE INCHES, ORDER NO., PRICE PER PIECE. Lists split cylinder sizes and prices for Grade C2.

- Tolerances: Blank Dia. +.000-.001, Flat Thickness +.004-.000
• Flat Length is equal to Cutter Diameter +1/8"
• Always wear safety glasses while operating power tools.
• Cutter Grinder Wheels for Carbide (Diamond Wheels) page 180

QUANTITY DISCOUNTS

24+ OF SAME SIZE 10%
144+ OF SAME SIZE 15%

Falcon Carbide Cylinders & Split Blanks

Cylinders / Grade C6

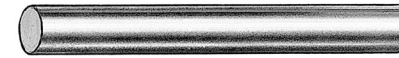

Table with 3 columns: SIZE INCHES, ORDER NO., PRICE PER PIECE. Lists various cylinder sizes and prices for Grade C6.

"A" - Split One End / Grade C6

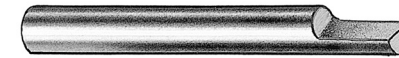

Table with 3 columns: SIZE INCHES, ORDER NO., PRICE PER PIECE. Lists split cylinder sizes and prices for Grade C6.

"B" - Split Both Ends / Grade C6

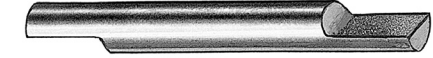

Table with 3 columns: SIZE INCHES, ORDER NO., PRICE PER PIECE. Lists split cylinder sizes and prices for Grade C6.

- Tolerances: Blank Dia. +.000-.001, Flat Thickness +.004-.000
• Flat Length is equal to Cutter Diameter +1/8"
• Always wear safety glasses while operating power tools.
• Cutter Grinder Wheels for Carbide (Diamond Wheels) page 180

QUANTITY DISCOUNTS

24+ OF SAME SIZE 10%
144+ OF SAME SIZE 15%



Falcon Carbide Cylinders & Split Blanks

Cylinders / Micrograin

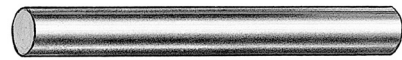

Table with 3 columns: SIZE INCHES, ORDER NO., PRICE PER PIECE. Lists various carbide cylinder sizes and prices.

"A" - Split One End / Micrograin

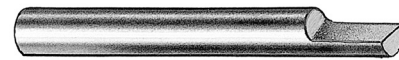

Table with 3 columns: SIZE INCHES, ORDER NO., PRICE PER PIECE. Lists split carbide cylinder sizes and prices.

"B" - Split Both Ends / Micrograin

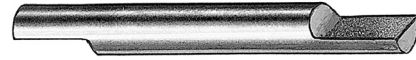

Table with 3 columns: SIZE INCHES, ORDER NO., PRICE PER PIECE. Lists split carbide cylinder sizes and prices.

- Tolerances: Blank Dia. +.000-.001, Flat Thickness +.004-.000
• Flat Length is equal to Cutter Diameter +1/8"
• Always wear safety glasses while operating power tools.
• Cutter Grinder Wheels for Carbide (Diamond Wheels) page 180

QUANTITY DISCOUNTS
24+ OF SAME SIZE 10%
144+ OF SAME SIZE 15%

Falcon Super HSS Blanks, 62-64 Rockwell "C"

Cylinders / Grade M2

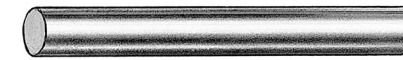

Table with 3 columns: SIZE INCHES, ORDER NO., PRICE PER PIECE. Lists Super HSS cylinder sizes and prices.

"A" - Split One End / Grade M2

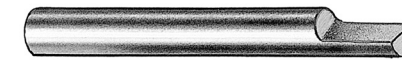

Table with 3 columns: SIZE INCHES, ORDER NO., PRICE PER PIECE. Lists split Super HSS cylinder sizes and prices.

"B" - Split Both Ends / Grade M2



Table with 3 columns: SIZE INCHES, ORDER NO., PRICE PER PIECE. Lists split Super HSS cylinder sizes and prices.

- Tolerances: Blank Dia. +.000-.001, Flat Thickness +.004-.000
• Flat Length is equal to Cutter Diameter + 5/16"
• Section 4C items are available in limited quantities and may be discontinued without notification.

QUANTITY DISCOUNTS
24+ OF SAME SIZE 5%
50+ OF SAME SIZE 10%
100+ OF SAME SIZE 15%

Falcon Easi-Grind Cobalt Blanks, 62-64 Rockwell "C"

Cylinders / Grade M42



Table with 3 columns: SIZE INCHES, ORDER NO., PRICE PER PIECE. Lists Easi-Grind cobalt cylinder sizes and prices.

"A" - Split One End / Grade M42



Table with 3 columns: SIZE INCHES, ORDER NO., PRICE PER PIECE. Lists split Easi-Grind cobalt cylinder sizes and prices.

"B" - Split Both Ends / Grade M42

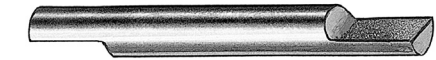

Table with 3 columns: SIZE INCHES, ORDER NO., PRICE PER PIECE. Lists split Easi-Grind cobalt cylinder sizes and prices.

- Tolerances: Blank Dia. +.000-.001, Flat Thickness +.004-.000
• Flat Length is equal to Cutter Diameter + 5/16"
• Section 4D items are available in limited quantities and may be discontinued without notification.

QUANTITY DISCOUNTS
24+ OF SAME SIZE 5%
50+ OF SAME SIZE 10%
100+ OF SAME SIZE 15%

Note: The Super HSS and Easi-Grind Cutter Blanks may be ground with any standard wheel or our 60 or 80 Grit Ruby Wheel.



Falcon Half Rounds

Eliminate Grinding Flats on Single Lip Engraving or Duplicating Cutters

Carbide Half Rounds



Put two carbide half rounds together.

SIZE INCHES	ORDER NO.	PRICE PER HALF
1/8 x 1-1/2	04E-CHR1000	\$4.90
3/16 x 2	04E-CHR1001	\$7.75
1/4 x 2	04E-CHR1002	\$12.10
5/16 x 3	04E-CHR1003	\$21.85
3/8 x 3	04E-CHR1004	\$27.50
1/2 x 3	04E-CHR1005	\$41.05

Super HSS Half Rounds



By sliding and rotating halves, you get four flats... ready to be ground into cutters.

SIZE INCHES	ORDER NO.	PRICE PER HALF
1/8 x 1-1/2	04F-HHR1000	\$3.80
3/16 x 2	04F-HHR1001	\$6.30
1/4 x 2	04F-HHR1002	\$7.30
5/16 x 3	04F-HHR1003	\$10.15
3/8 x 3	04F-HHR1004	\$12.80
1/2 x 3	04F-HHR1005	\$17.20

- Tolerances: Flat Thickness +.0005-.0005
- Section 4F items are available in limited quantities and may be discontinued without notification.

QUANTITY DISCOUNTS

- 24+ OF SAME SIZE 10%
- 50+ OF SAME SIZE 15%

Falcon Super HSS Midget Taper Shank Engraving Cutters



STYLE NO.	POINT DIA.	ORDER NO.	PRICE
#61 HSS	.150	04B-TEC1000	\$11.25

Falcon Square Carbide Blanks

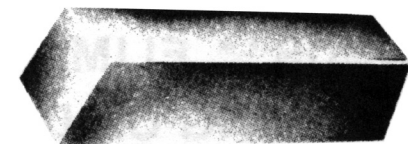

SIZE INCHES	MODEL	ORDER NO.	PRICE
3/16 x 1-1/4	FSC-2	04G-SQB2000	\$21.05
1/4 x 1-1/4	FSC-3	04G-SQB2001	\$30.10
5/16 x 1-1/2	FSC-4	04G-SQB2002	\$19.25
3/8 x 1-3/4	FSC-5	04G-SQB2003	\$39.90

QUANTITY DISCOUNTS

- 10+ OF SAME SIZE 10%

Falcon Mounted Point Sets

Save up to 50%

Available in Blue, Brown or White*

Blue: Hard • Brown: Medium Hard • White: Regular

100 PIECE SET

BP-100 has 10 pcs. each:

W-144	W-185
W-152	W-200
W-163	B-44
W-170	B-52
W-176	B-123

48 PIECE SET

6 pcs. each:

W-144	B-44
W-152	B-52
W-162	B-123
W-176	
W-200	

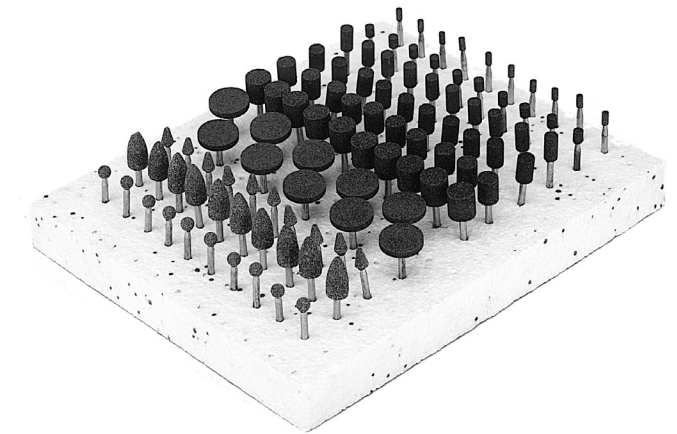

SET SIZE	SET NO.	ORDER NO.			PRICE
		BLUE	BROWN	WHITE	
100 Pc. Set on 1/8" Shank, 10 of a kind (10 each)	BP-100	05A-MPT9000	05A-MPT9100	05A-MPT9200	\$60.00
48 Pc. Set on 1/8" Shank, 6 Pcs of each: B-44, B-52, B-123, W-144, W-152, W-162, W-176, W-200		05A-MPT9300	05-MPT9301	05A-MPT9302	\$31.00

Max Safe Speed: 45370 RPM

Premium Purple Mounted Point Sets

An economical way to have a selection of points in your toolkit for any application.

All Premium Purple Mounted Points have a 1/8" mandrel.

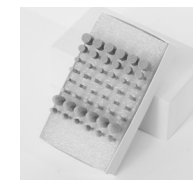

PIECES PER SHAPE	SHAPES INCLUDED	TOTAL PIECES PER KIT	ORDER NO.	PRICE
6	B44, B52, B123, W144, W146, W152, W162, W176	48	05P-KIT9000	\$57.95
10	B44, B52, B53, B123, B135, W146, W152, W163, W176, W185	100	05P-KIT9001	\$100.00



Mounted Points, 1/8" Shank

- Blue: Hard, Brown: Medium-Hard, White: Regular
- Always wear proper eye protection while using rotary power tool accessories.

PRICES PER PACK:
Packaged in 25 pc. quantities

25 pieces	\$16.25
100 pieces	\$13.75
200 pieces	\$11.25

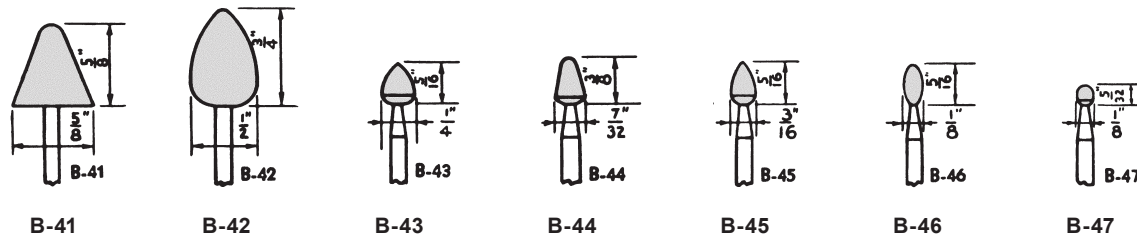

BLUE	05A-MPT1041	05A-MPT1042	05A-MPT1043	05A-MPT1044	05A-MPT1045	05A-MPT1046	05A-MPT1047
BROWN	05A-MPT2041	05A-MPT2042	05A-MPT2043	05A-MPT2044	05A-MPT2045	05A-MPT2046	05A-MPT2047
WHITE	05A-MPT3041	05A-MPT3042	05A-MPT3043	05A-MPT3044	05A-MPT3045	05A-MPT3046	05A-MPT3047

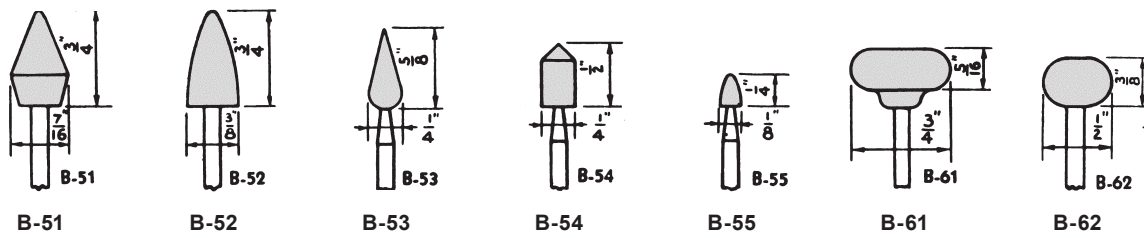

BLUE	05A-MPT1051	05A-MPT1052	05A-MPT1053	05A-MPT1054	05A-MPT1055	05A-MPT1061	05A-MPT1062
BROWN	05A-MPT2051	05A-MPT2052	05A-MPT2053	05A-MPT2054	05A-MPT2055	05A-MPT2061	05A-MPT2062
WHITE	05A-MPT3051	05A-MPT3052	05A-MPT3053	05A-MPT3054	05A-MPT3055	-	05A-MPT3062

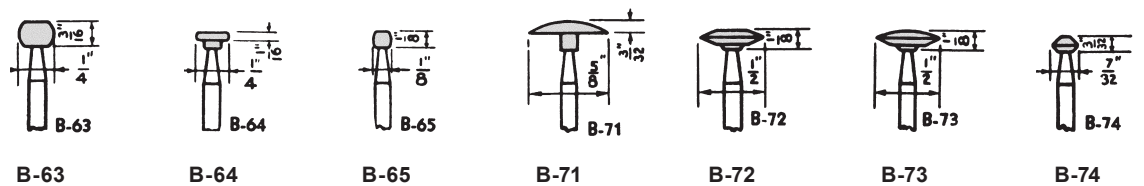

BLUE	05A-MPT1063	05A-MPT1064	05A-MPT1065	05A-MPT1071	05A-MPT1072	05A-MPT1073	05A-MPT1074
BROWN	05A-MPT2063	05A-MPT2064	05A-MPT2065	05A-MPT2071	05A-MPT2072	05A-MPT2073	05A-MPT2074
WHITE	05A-MPT3063	05A-MPT3064	05A-MPT3065	05A-MPT3071	05A-MPT3072	05A-MPT3073	05A-MPT3074

For sets, see page 51.

Mounted Points, 1/8" Shank

- Blue: Hard, Brown: Medium-Hard, White: Regular
- Always wear proper eye protection while using rotary power tool accessories.

PRICES PER PACK:
Packaged in 25 pc. quantities

25 pieces	\$16.25
100 pieces	\$13.75
200 pieces	\$11.25

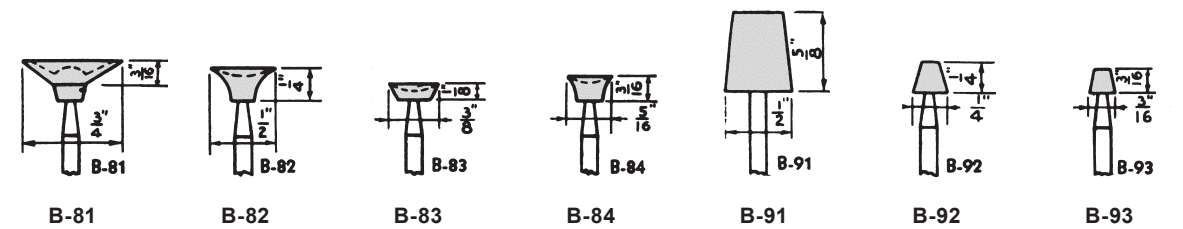

BLUE	05A-MPT1081	05A-MPT1082	05A-MPT1083	05A-MPT1084	05A-MPT1091	05A-MPT1092	05A-MPT1093
BROWN	05A-MPT2081	05A-MPT2082	05A-MPT2083	05A-MPT2084	05A-MPT2091	05A-MPT2092	05A-MPT2093
WHITE	05A-MPT3081	05A-MPT3082	05A-MPT3083	05A-MPT3084	05A-MPT3091	05A-MPT3092	05A-MPT3093

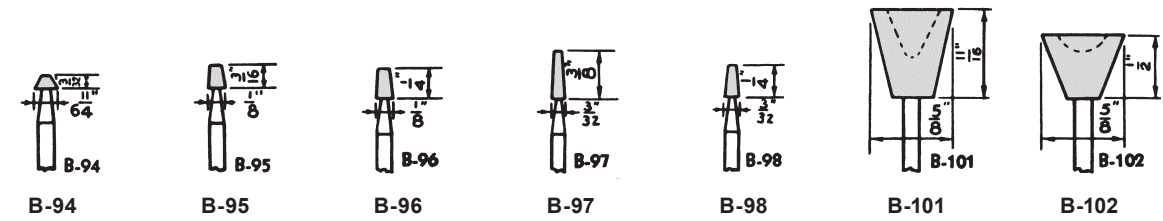

BLUE	05A-MPT1094	05A-MPT1095	05A-MPT1096	05A-MPT1097	05A-MPT1098	05A-MPT1101	05A-MPT1102
BROWN	05A-MPT2094	05A-MPT2095	05A-MPT2096	05A-MPT2097	05A-MPT2098	05A-MPT2101	05A-MPT2102
WHITE	05A-MPT3094	05A-MPT3095	05A-MPT3096	05A-MPT3097	05A-MPT3098	05A-MPT3101	05A-MPT3102

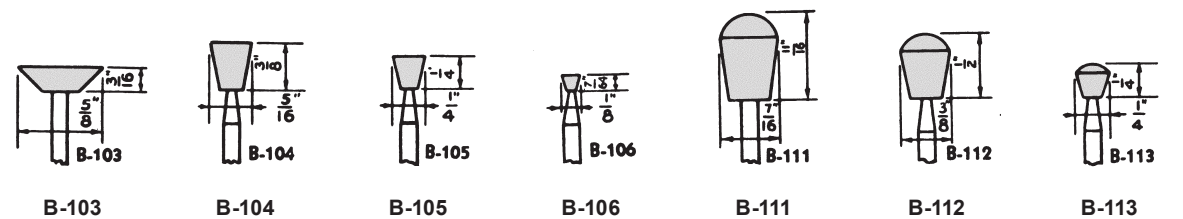

BLUE	05A-MPT1103	05A-MPT1104	05A-MPT1105	05A-MPT1106	05A-MPT1111	05A-MPT1112	05A-MPT1113
BROWN	05A-MPT2103	05A-MPT2104	05A-MPT2105	05A-MPT2106	05A-MPT2111	05A-MPT2112	05A-MPT2113
WHITE	05A-MPT3103	05A-MPT3104	05A-MPT3105	05A-MPT3106	05A-MPT3111	05A-MPT3112	05A-MPT3113

For sets, see page 51.



Mounted Points, 1/8" Shank

- Blue: Hard, Brown: Medium-Hard, White: Regular
- Always wear proper eye protection while using rotary power tool accessories.

PRICES PER PACK:
Packaged in 25 pc. quantities

25 pieces	\$16.25
100 pieces	\$13.75
200 pieces	\$11.25

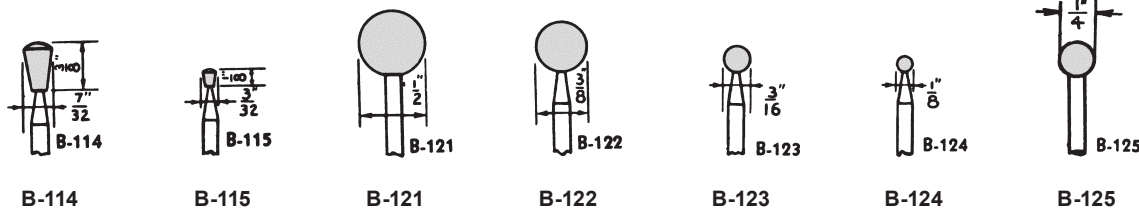

	B-114	B-115	B-121	B-122	B-123	B-124	B-125
BLUE	05A-MPT1114	05A-MPT1115	05A-MPT1121	05A-MPT1122	05A-MPT1123	05A-MPT1124	05A-MPT1125
BROWN	05A-MPT2114	05A-MPT2115	05A-MPT2121	05A-MPT2122	05A-MPT2123	05A-MPT2124	05A-MPT2125
WHITE	05A-MPT3114	05A-MPT3115	05A-MPT3121	05A-MPT3122	05A-MPT3123	05A-MPT3124	05A-MPT3125

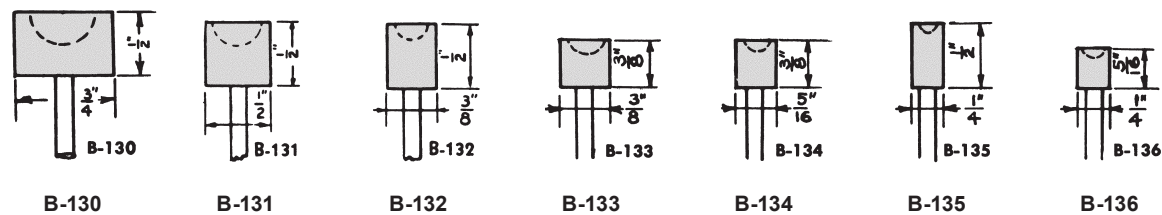

	B-130	B-131	B-132	B-133	B-134	B-135	B-136
BLUE	05A-MPT1130	05A-MPT1131	05A-MPT1132	05A-MPT1133	05A-MPT1134	05A-MPT1135	05A-MPT1136
BROWN	05A-MPT2130	05A-MPT2131	05A-MPT2132	05A-MPT2133	05A-MPT2134	05A-MPT2135	05A-MPT2136
WHITE	05A-MPT3130	05A-MPT3131	05A-MPT3132	05A-MPT3133	05A-MPT3134	05A-MPT3135	05A-MPT3136

For sets, see page 51.

Falcon Mounted Point Truing Stones

Coarse silicon carbide stone with 1/16", 1/8", 3/16" and 1/4" grooves. Used to dress, shape and clean mounted points. Quickly reshapes and resurfaces abrasive stones and points to like-new condition. Available with v-shaped or rounded grooves.

GROOVE SHAPE	ORDER NO.	PRICE
V-Shaped	02R-TRU1000	\$5.00
Rounded	02R-TRU2000	\$5.00

Falcon Premium Purple Mounted Points

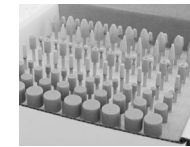

Premium Purple Mounted Points are an extremely long lasting but cool cutting alternative to standard mounted points. Premium Pink fused aluminum oxide grain combined with unique Sol Gel ceramic grain provides up to double the life of a standard mounted point. Premium Purple Mounted Points can be used on all ferrous & non-ferrous materials.



Falcon Premium Purple Mounted Points

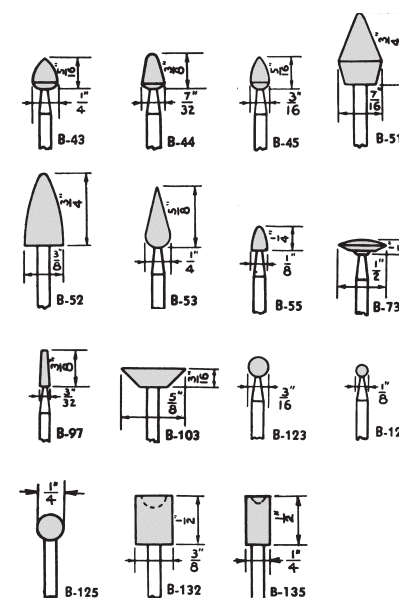

B SHAPES

1/8" MANDREL	80 GRIT	100 GRIT	120 GRIT
B43 1/4 x 5/16	05P-MPT4043	-	-
B44 7/32 x 3/8	-	05P-MPT4044	-
B45 3/16 x 5/16	-	05P-MPT4045	-
B51 7/16 x 3/4	05P-MPT4051	-	-
B52 3/8 x 3/4	05P-MPT4052	-	-
B53 1/4 x 5/8	-	-	05P-MPT4053
B55 1/8 x 1/4	-	-	05P-MPT4055
B73 1/2 x 1/8	05P-MPT4073	-	-
B97 1/8 x 3/8	-	-	05P-MPT4097
B103 5/8 x 3/16	-	05P-MPT4103	-
B123 3/16 x 3/16	-	05P-MPT4123	-
B124 1/8 x 1/8	-	-	05P-MPT4124
B125 1/4 x 1/4	-	05P-MPT4125	-
B132 3/8 x 1/2	05P-MPT4132	-	-
B135 1/4 x 1/2	05P-MPT4135	-	-

PRICES PER PACK:
Packaged in 25 pc. quantities

25 pieces	\$25.00
100 pieces	\$23.75
200 pieces	\$22.50

W SHAPES

1/8" MANDREL	80 GRIT	100 GRIT	120 GRIT
W142 3/32 x 1/4	-	-	05P-MWH4142
W144 1/8 x 1/4	-	-	05P-MWH4144
W145 1/8 x 3/8	-	-	05P-MWH4145
W146 1/8 x 1/2	-	-	05P-MWH4146
W152 3/16 x 1/4	05P-MWH4152	-	-
W153 3/16 x 3/8	05P-MWH4153	-	-
W154 3/16 x 1/2	05P-MWH4154	-	-
W160 1/4 x 1/4	-	-	-
W162 1/4 x 3/8	05P-MWH4162	-	-
W163 1/4 x 1/2	05P-MWH4163	-	-
W164 1/4 x 3/4	-	05P-MWH4164	-
W175 3/8 x 3/8	05P-MWH4175	-	-
W176 3/8 x 1/2	05P-MWH4176	-	-
W182 1/2 x 1/8	-	05P-MWH4182	-
W185 1/2 x 1/2	05P-MWH4185	-	-

PRICES PER PACK:
Packaged in 25 pc. quantities

25 pieces	\$25.00
100 pieces	\$23.75
200 pieces	\$22.50



Mounted Wheels, 1/8" Shank

- Blue: Hard, Brown: Medium-Hard, White: Regular
- Always wear proper eye protection while using rotary power tool accessories

PRICES PER PACK:
Packaged in 25 pc. quantities

25 pieces	\$16.25
100 pieces	\$13.75
200 pieces	\$11.25

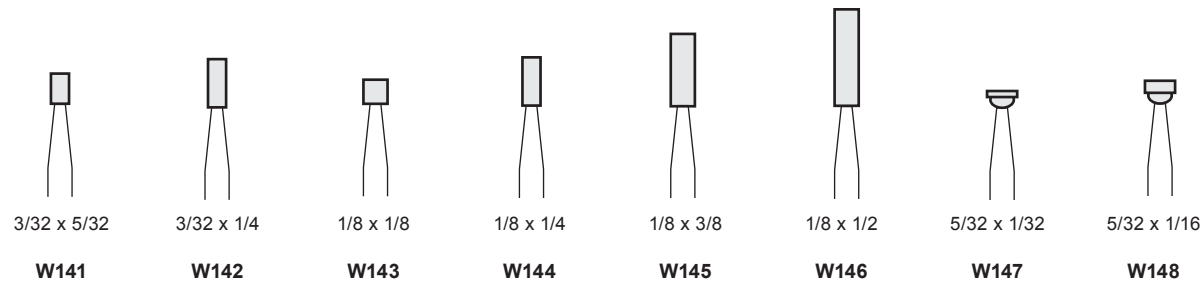

BLUE	05B-MWH1141	05B-MWH1142	05B-MWH1143	05B-MWH1144	05B-MWH1145	05B-MWH1146	05B-MWH1147	05B-MWH1148
BROWN	05B-MWH2141	05B-MWH2142	05B-MWH2143	05B-MWH2144	05B-MWH2145	05B-MWH2146	05B-MWH2147	05B-MWH2148
WHITE	05B-MWH3141	05B-MWH3142	05B-MWH3143	05B-MWH3144	05B-MWH3145	05B-MWH3146	05B-MWH3147	05B-MWH3148

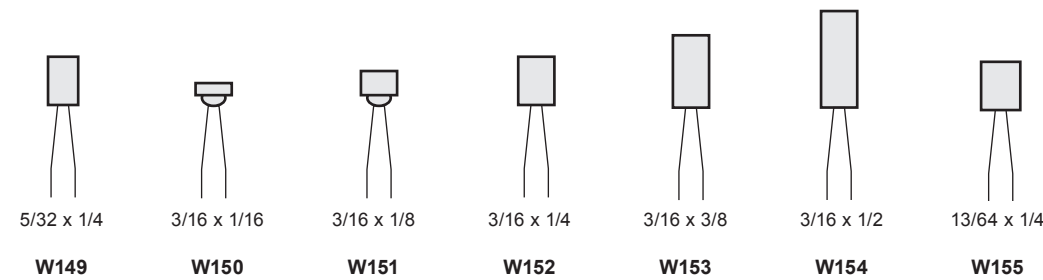

BLUE	05B-MWH1149	05B-MWH1150	05B-MWH1151	05B-MWH1152	05B-MWH1153	05B-MWH1154	05B-MWH1155
BROWN	05B-MWH2149	05B-MWH2150	05B-MWH2151	05B-MWH2152	05B-MWH2153	05B-MWH2154	05B-MWH2155
WHITE	05B-MWH3149	05B-MWH3150	05B-MWH3151	05B-MWH3152	05B-MWH3153	05B-MWH3154	05B-MWH3155

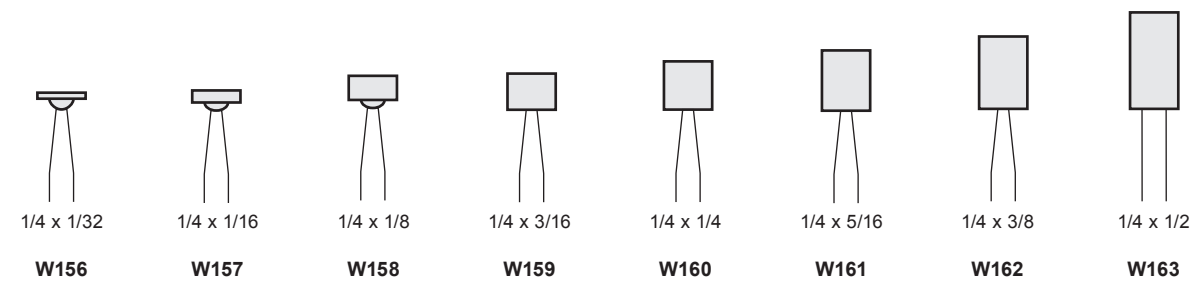

BLUE	05B-MWH1156	05B-MWH1157	05B-MWH1158	05B-MWH1159	05B-MWH1160	05B-MWH1161	05B-MWH1162	05B-MWH1163
BROWN	05B-MWH2156	05B-MWH2157	05B-MWH2158	05B-MWH2159	05B-MWH2160	05B-MWH2161	05B-MWH2162	05B-MWH2163
WHITE	05B-MWH3156	05B-MWH3157	05B-MWH3158	05B-MWH3159	05B-MWH3160	05B-MWH3161	05B-MWH3162	05B-MWH3163

For sets, see page 51.

Mounted Wheels, 1/8" Shank

- Blue: Hard, Brown: Medium-Hard, White: Regular
- Always wear proper eye protection while using rotary power tool accessories

PRICES PER PACK:
Packaged in 25 pc. quantities

25 pieces	\$16.25
100 pieces	\$13.75
200 pieces	\$11.25

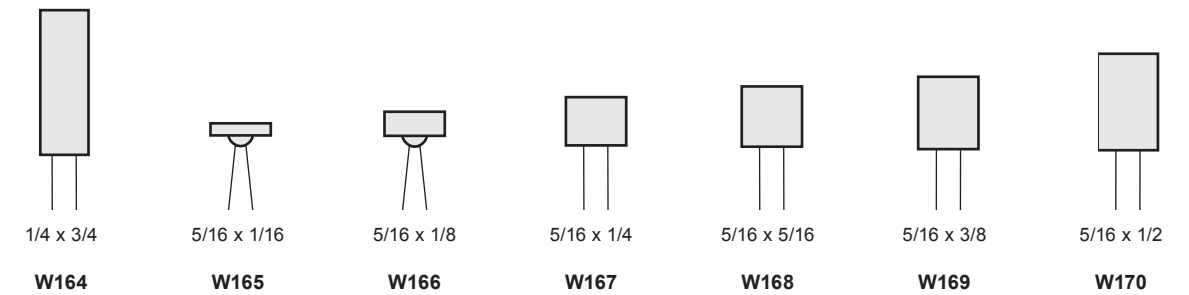

BLUE	05B-MWH1164	05B-MWH1165	05B-MWH1166	05B-MWH1167	05B-MWH1168	05B-MWH1169	05B-MWH1170
BROWN	05B-MWH2164	05B-MWH2165	05B-MWH2166	05B-MWH2167	05B-MWH2168	05B-MWH2169	05B-MWH2170
WHITE	05B-MWH3164	05B-MWH3165	05B-MWH3166	05B-MWH3167	05B-MWH3168	05B-MWH3169	05B-MWH3170

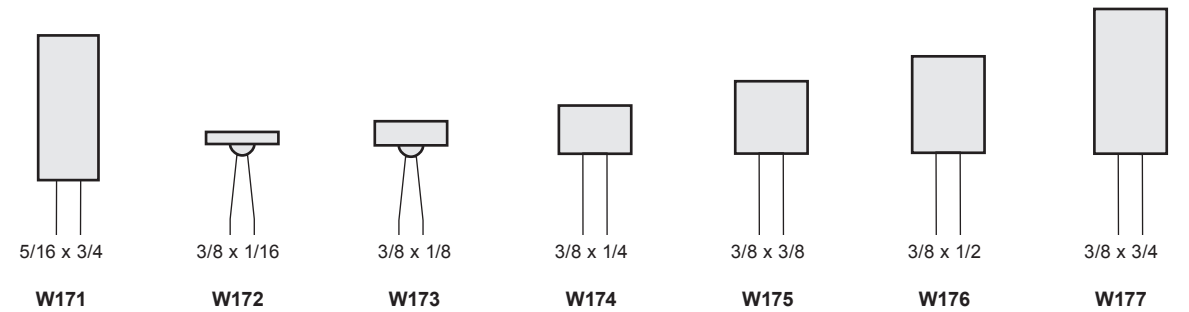

BLUE	05B-MWH1171	05B-MWH1172	05B-MWH1173	05B-MWH1174	05B-MWH1175	05B-MWH1176	05B-MWH1177
BROWN	05B-MWH2171	05B-MWH2172	05B-MWH2173	05B-MWH2174	05B-MWH2175	05B-MWH2176	05B-MWH2177
WHITE	05B-MWH3171	05B-MWH3172	05B-MWH3173	05B-MWH3174	05B-MWH3175	05B-MWH3176	05B-MWH3177

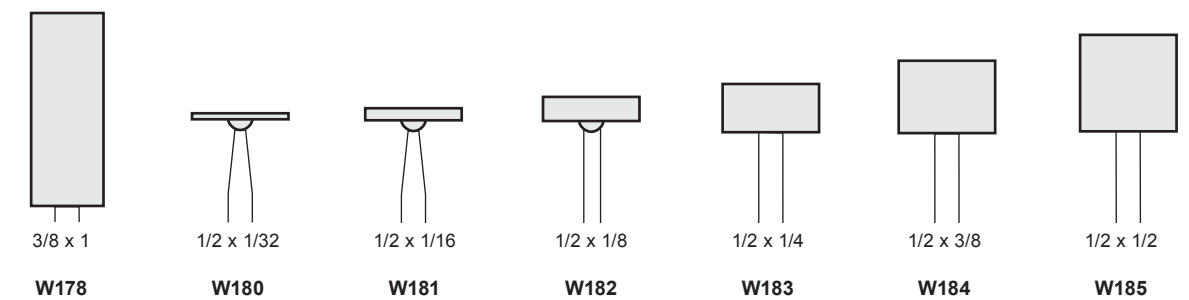

BLUE	05B-MWH1178	05B-MWH1180	05B-MWH1181	05B-MWH1182	05B-MWH1183	05B-MWH1184	05B-MWH1185
BROWN	05B-MWH2178	05B-MWH2180	05B-MWH2181	05B-MWH2182	05B-MWH2183	05B-MWH2184	05B-MWH2185
WHITE	05B-MWH3178	05B-MWH3180	05B-MWH3181	05B-MWH3182	05B-MWH3183	05B-MWH3184	05B-MWH3185

For sets, see page 51.



Mounted Wheels, 1/8" Shank

- Blue: Hard, Brown: Medium-Hard, White: Regular
- Always wear proper eye protection while using rotary power tool accessories

PRICES PER PACK:
 Packaged in 25 pc. quantities

25 pieces	\$16.25
100 pieces	\$13.75
200 pieces	\$11.25

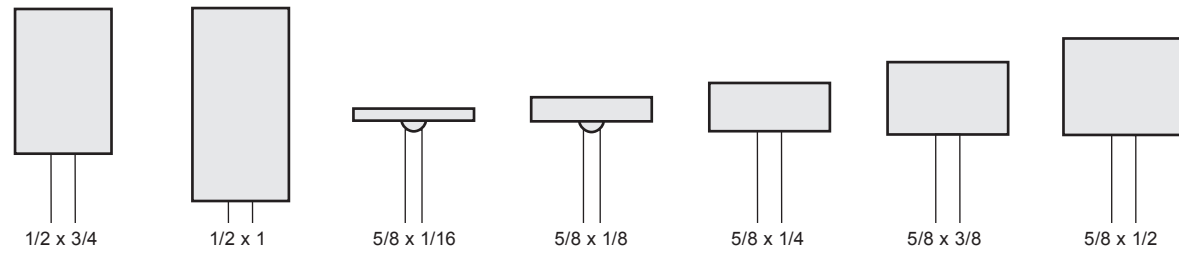

Color	W186	W187	W190	W191	W192	W193	W194
BLUE	05B-MWH1186	05B-MWH1187	05B-MWH1190	05B-MWH1191	05B-MWH1192	05B-MWH1193	05B-MWH1194
BROWN	05B-MWH2186	05B-MWH2187	05B-MWH2190	05B-MWH2191	05B-MWH2192	05B-MWH2193	05B-MWH2194
WHITE	05B-MWH3186	05B-MWH3187	05B-MWH3190	05B-MWH3191	05B-MWH3192	05B-MWH3193	05B-MWH3194

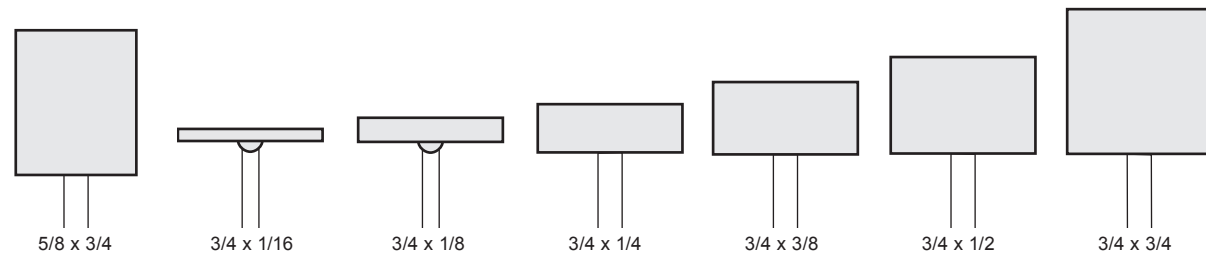

Color	W195	W199	W200	W201	W202	W203	W204**
BLUE	05B-MWH1195	05B-MWH1199	05B-MWH1200	05B-MWH1201	05B-MWH1202	05B-MWH1203	05B-MWH1204
BROWN	05B-MWH2195	05B-MWH2199	05B-MWH2200	05B-MWH2201	05B-MWH2202	05B-MWH2203	05B-MWH2204
WHITE	05B-MWH3195	05B-MWH3199	05B-MWH3200	05B-MWH3201	05B-MWH3202	05B-MWH3203	05B-MWH3204

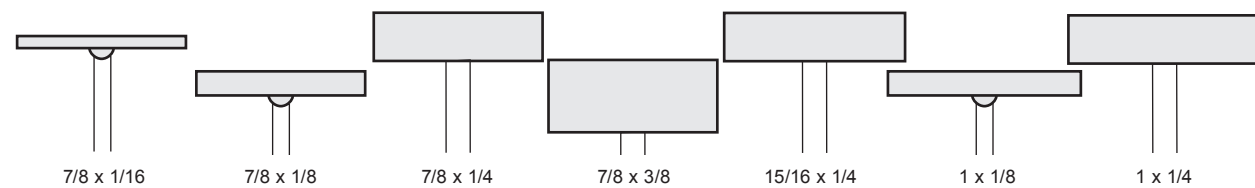

Color	W210	W211	W212	W213	W214	W215	W216**
BLUE	05B-MWH1210	05B-MWH1211	05B-MWH1212	05B-MWH1213	05B-MWH1214	05B-MWH1215	05B-MWH1216
BROWN	05B-MWH2210	05B-MWH2211	05B-MWH2212	05B-MWH2213	05B-MWH2214	05B-MWH2215	05B-MWH2216
WHITE	05B-MWH3210	05B-MWH3211	05B-MWH3212	05B-MWH3213	05B-MWH3214	05B-MWH3215	05B-MWH3216

**Also available in 1/4" shank

For sets, see page 51.

Mounted Wheels, 1/4" & 3/8" Shank

- Blue: Hard, Brown: Medium-Hard, White: Regular
- Always wear proper eye protection while using rotary power tool accessories
- Packaged in quantities of 25 pieces



----- ORDER NO. -----

SHAPE NO.	DIAMETER (D-INCHES)	LENGTH (L-INCHES)	SHANK SIZE	BLUE	BROWN	WHITE	PRICE EACH
W188	1/2	1-1/2	1/4"	05C-MWH1188	05C-MWH2188	05C-MWH3188	\$1.00
W189	1/2	2	1/4"	05C-MWH1189	05C-MWH2189	05C-MWH3189	\$1.15
W196	5/8	1	1/4"	05C-MWH1196	05C-MWH2196	05C-MWH3196	\$1.20
W197	5/8	2	1/4"	05C-MWH1197	05C-MWH2197	05C-MWH3197	\$1.20
W198	5/8	2-1/2	1/4"	05C-MWH1198	05C-MWH2198	05C-MWH3198	\$1.45
W204	3/4	3/4	1/4"	05C-MWH1204	05C-MWH2204	05C-MWH3204	\$0.70
W205	3/4	1	1/4"	05C-MWH1205	05C-MWH2205	05C-MWH3205	\$0.80
W206	3/4	1-1/4	1/4"	05C-MWH1206	05C-MWH2206	05C-MWH3206	\$0.85
W207	3/4	1-1/2	1/4"	05C-MWH1207	05C-MWH2207	05C-MWH3207	\$0.95
W208	3/4	2	1/4"	05C-MWH1208	05C-MWH2208	05C-MWH3208	\$1.20
W209	3/4	2-1/2	1/4"	05C-MWH1209	05C-MWH2209	05C-MWH3209	\$1.45
W216	1	1/4	1/4"	05C-MWH1216	05C-MWH2216	05C-MWH3216	\$0.65
W217	1	3/8	1/4"	05C-MWH1217	05C-MWH2217	05C-MWH3217	\$0.70
W218	1	1/2	1/4"	05C-MWH1218	05C-MWH2218	05C-MWH3218	\$0.70
W219	1	3/4	1/4"	05C-MWH1219	05C-MWH2219	05C-MWH3219	\$0.75
W220	1	1	1/4"	05C-MWH1220	05C-MWH2220	05C-MWH3220	\$0.80
W221	1	1-1/2	1/4"	05C-MWH1221	05C-MWH2221	05C-MWH3221	\$1.05
W222	1	2	1/4"	05C-MWH1222	05C-MWH2222	05C-MWH3222	\$1.30
W223	1	2-1/2	1/4"	05C-MWH1223	05C-MWH2223	05C-MWH3223	\$1.55
W224	1	3	3/8"	05C-MWH1224	05C-MWH2224	05C-MWH3224	\$2.10
W225	1-1/4	1/4	1/4"	05C-MWH1225	05C-MWH2225	05C-MWH3225	\$0.70

For sets, see page 51.

QUANTITY DISCOUNTS

100 EACH OF SAME SIZE & TYPE 10%
(minimum order quantity of 25)

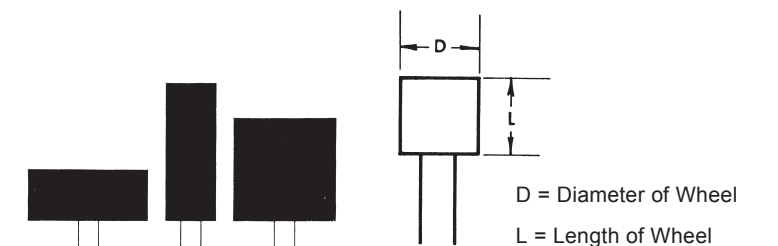



Mounted Wheels, 1/4" & 3/8" Shank

- Blue: Hard, Brown: Medium-Hard, White: Regular
- Always wear proper eye protection while using rotary power tool accessories
- Packaged in quantities of 25 pieces



SHAPE NO.	DIAMETER (D-INCHES)	LENGTH (L-INCHES)	SHANK SIZE	ORDER NO.			PRICE EACH
				BLUE	BROWN	WHITE	
W226	1-1/4	3/8	1/4"	05C-MWH1226	05C-MWH2226	05C-MWH3226	\$0.75
W227	1-1/4	1/2	1/4"	05C-MWH1227	05C-MWH2227	05C-MWH3227	\$0.75
W228	1-1/4	3/4	1/4"	05C-MWH1228	05C-MWH2228	05C-MWH3228	\$0.80
W229	1-1/4	1	1/4"	05C-MWH1229	05C-MWH2229	05C-MWH3229	\$0.90
W230	1-1/4	1-1/4	1/4"	05C-MWH1230	--	05C-MWH3230	\$1.05
W231	1-1/4	1-1/2	1/4"	05C-MWH1231	05C-MWH2231	05C-MWH3231	\$1.25
W232	1-1/4	2	1/4"	05C-MWH1232	05C-MWH2232	05C-MWH3232	\$1.55
W233	1-1/4	2-1/2	3/8"	05C-MWH1233	05C-MWH2233	05C-MWH3233	\$2.35
W234	1-1/4	3	3/8"	05C-MWH1234	05C-MWH2234	05C-MWH3234	\$2.65
W235	1-1/2	1/4	1/4"	05C-MWH1235	05C-MWH2235	05C-MWH3235	\$0.75
W236	1-1/2	1/2	1/4"	05C-MWH1236	05C-MWH2236	05C-MWH3236	\$0.80
W237	1-1/2	1	1/4"	05C-MWH1237	05C-MWH2237	05C-MWH3237	\$0.95
W238	1-1/2	1-1/2	1/4"	05C-MWH1238	05C-MWH2238	05C-MWH3238	\$1.30
W239	1-1/2	2	3/8"	05C-MWH1239	05C-MWH2239	05C-MWH3239	\$2.10
W240	1-1/2	2-1/2	3/8"	05C-MWH1240	05C-MWH2240	05C-MWH3240	\$2.40
W241	1-1/2	3	3/8"	05C-MWH1241	05C-MWH2241	05C-MWH3241	\$2.65
W242	2	1	1/4"	05C-MWH1242	05C-MWH2242	05C-MWH3242	\$1.20
W243	2	1-1/2	3/8"	05C-MWH1243	05C-MWH2243	05C-MWH3243	\$2.10
W244	2	2	3/8"	05C-MWH1244	05C-MWH2244	05C-MWH3244	\$2.45
W245	2	2-1/2	3/8"	05C-MWH1245	05C-MWH2245	05C-MWH3245	\$2.75
W246	2	3	3/8"	05C-MWH1246	05C-MWH2246	05C-MWH3246	\$3.15

For sets, see page 51.

QUANTITY DISCOUNTS
100 EACH OF SAME SIZE & TYPE 10%
 (minimum order quantity of 25)

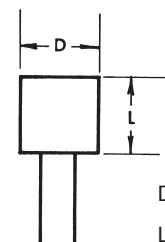

D = Diameter of Wheel
 L = Length of Wheel

Midget Abrasive Points, 3/32" Shank

- Blue: Standard Hardness, Pink: Extremely Hard, White: Very Fine (400 Grit)
- Pictures are actual size

PRICES: Minimum order quantity of 25
 All shapes except 05, 12, 13 \$50.50 per pkg of 25
 Shapes 05, 12, 13..... \$80.25 per pkg of 25

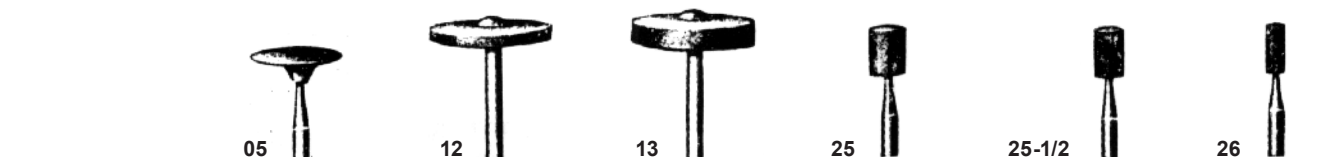

	05	12	13	25	25-1/2	26
BLUE	05E-MAP1000	-	-	-	-	05E-MAP1005
PINK	-	-	-	-	-	05E-MAP2005
WHITE	-	-	-	-	-	-



	26-1/2	27	31	31-1/8	31-1/2	31-5/8
BLUE	05E-MAP1006	-	05E-MAP1008	05E-MAP1009	05E-MAP1010	05E-MAP1011
PINK	05E-MAP2006	05E-MAP2007	05E-MAP2008	05E-MAP2043	-	05E-MAP2044
WHITE	05E-MAP3006	05E-MAP3007	-	-	-	-



	32-3/4	34	35	36	36-1/2	37
BLUE	05E-MAP1012	05E-MAP1013	05E-MAP1014	05E-MAP1015	05E-MAP1016	05E-MAP1017
PINK	05E-MAP2009	05E-MAP2010	05E-MAP2011	05E-MAP2012	-	05E-MAP2014
WHITE	05E-MAP3009	05E-MAP3010	05E-MAP3011	-	-	05E-MAP3014



	37-1/2	40	40-1/2	41-1/2	41-3/4	44
BLUE	05E-MAP1018	05E-MAP1019	05E-MAP1020	05E-MAP1021	05E-MAP1022	05E-MAP1023
PINK	-	05E-MAP2016	05E-MAP2017	05E-MAP2018	-	05E-MAP2020
WHITE	05E-MAP3015	05E-MAP3016	05E-MAP3017	-	-	05E-MAP3020



Midget Abrasive Points, 3/32" Shank

- Blue: Standard Hardness, Pink: Extremely Hard, White: Very Fine (400 Grit)
- Pictures are actual size

PRICES: Minimum order quantity of 25
 All shapes except 05, 12, 13 \$50.50 per package of 25
 Shapes 05, 12, 13..... \$80.25 per package of 25



BLUE	05E-MAP1024	05E-MAP1025	05E-MAP1026	05E-MAP1027	05E-MAP1028	05E-MAP1029
PINK	05E-MAP2021	05E-MAP2022	-	05E-MAP2024	05E-MAP2025	-
WHITE	05E-MAP3021	05E-MAP3022	05E-MAP3023	05E-MAP3024	-	05E-MAP3026



BLUE	05E-MAP1030	05E-MAP1031	05E-MAP1032	05E-MAP1033	05E-MAP1034	05E-MAP1035
PINK	05E-MAP2027	05E-MAP2028	-	05E-MAP2030	-	-
WHITE	-	-	05E-MAP3029	-	-	05E-MAP3032



BLUE	05E-MAP1036	05E-MAP1037	05E-MAP1038	05E-MAP1039	05E-MAP1040	05E-MAP1041
PINK	-	05E-MAP2034	05E-MAP2035	05E-MAP2036	05E-MAP2037	05E-MAP2038
WHITE	-	-	05E-MAP3035	05E-MAP3036	-	-



BLUE	05E-MAP1042	05E-MAP1043	05E-MAP1044	05E-MAP1045
PINK	05E-MAP2039	05E-MAP2040	05E-MAP2041	05E-MAP2042
WHITE	05E-MAP3039	05E-MAP3040	05E-MAP3041	05E-MAP3042

Small Unmounted Grinding Wheels, 1/16" Hole

DIAMETER	7/16"	9/16"	5/8"	3/4"	7/8"	Price/pkg of 25
SHAPE NO.	100	104	108	119	112	
THICKNESS	1/16"	1/16"	1/16"	1/16"	1/16"	\$35.25
ORDER NO.	05F-UGR1100	05F-UGR1104	05F-UGR1108	05F-UGR1119	05F-UGR1112	
SHAPE NO.	101	105	109	118	113	
THICKNESS	1/8"	1/8"	1/8"	1/8"	1/8"	\$35.25
ORDER NO.	05F-UGR1101	05F-UGR1105	05F-UGR1109	05F-UGR1118	05F-UGR1113	
SHAPE NO.	102	106	110	117	114	
THICKNESS	3/16"	3/16"	3/16"	3/16"	3/16"	\$35.25
ORDER NO.	05F-UGR1102	05F-UGR1106	05F-UGR1110	05F-UGR1117	05F-UGR1114	

Larger Size Unmounted Grinding Wheels

SHAPE NO.	DIAMETER (D-INCHES)	LENGTH (L-INCHES)	HOLE (INCHES)	ORDER NO.	PRICE/PKG OF 25
190	1	1/8	1/8	05F-UGR1190	\$16.25
192	1-1/2	1/4	1/4	05F-UGR1192	\$30.00
193	2	1/4	1/4	05F-UGR1193	\$36.25

QUANTITY DISCOUNTS FOR LARGER GRINDING WHEEL
 100 EACH, ALL SAME ORDER NO.....10%

Knife Edge Unmounted

DIAMETER	1/2"	5/8"	3/4"	7/8"	1"	PRICE/PKG OF 25
SHAPE NO.	130	130-1/2	131	131-1/2	132	
ORDER NO.	05F-UGR1300	05F-UGR1305	05F-UGR1310	05F-UGR1315	05F-UGR1320	\$40.00

For mandrels, see page 106.



Falcon Cup Wheels for Cutter Grinders

Straight Cup

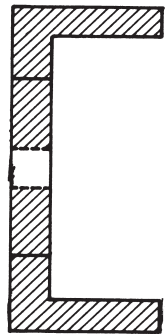

SHAPE NO.	ORDER NO.	DIMENSIONS	GRIT	PRICE EACH	PRICE 10 OR MORE	PRICE 20 OR MORE
Falcon, Deckel and Kuhlmann						
DKG-1	05G-CWH1001	4" x 2" x 25/32" (20 mm) x 1/2" face	Ruby 60	\$24.55	\$22.10	\$19.90
DKG-2	05G-CWH1002	4" x 2" x 25/32" (20 mm) x 1/2" face	Ruby 80	\$24.55	\$22.10	\$19.90
Silicon Carbide For Carbide Rough Grinding						
DKG-3	05G-CWH1003	4" x 2" x 25/32" (20 mm) x 1/2" face	Green 60	\$34.00	\$30.00	\$27.55
DKG-4	05G-CWH1004	4" x 2" x 25/32" (20 mm) x 1/2" face	Green 80	\$34.00	\$30.60	\$27.55

For Gorton

SHAPE NO.	ORDER NO.	DIMENSIONS	GRIT	PRICE EACH	PRICE 5 OR MORE	PRICE 10 OR MORE	PRICE 15 OR MORE
GG-1	05G-CWH2001	4" x 1" x 7/16" hole x 3/4" face	Ruby 60	\$17.20	-	-	\$15.50
GG-2	05G-CWH2002	4" x 1" x 7/16" hole x 3/4" face	Ruby 80	\$17.20	-	-	\$15.50
GG-3	05G-CWH2003	4" x 1-1/2" x 7/16" hole x 3/8" face	Ruby 60	\$23.05	-	-	\$20.75
GG-4	05G-CWH2004	4" x 1-1/2" x 7/16" hole x 3/8" face	Ruby 80	\$23.05	-	-	\$20.75
GG-5	05G-CWH2005	6" x 1-1/4" x 7/16" hole x 5/8" face	Ruby 60	\$34.35	\$30.95	\$27.85	\$27.85
GG-6	05G-CWH2006	6" x 1-1/4" x 7/16" hole x 5/8" face	Ruby 80	\$34.35	\$30.95	\$27.85	\$27.85

Flaring Cup

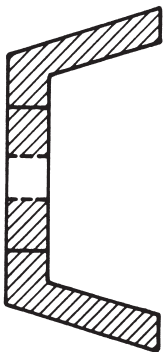

For Gorton

SHAPE NO.	ORDER NO.	DIMENSIONS	GRIT	PRICE EACH	PRICE 5 OR MORE	PRICE 10 OR MORE
GG-7	05G-CWH2007	4" 3/8" x 1-1/2" x 7/16" hole x 3/8" face	Ruby 60	\$23.05	-	\$20.75
GG-8	05G-CWH2008	4" 3/8" x 1-1/2" x 7/16" hole x 3/8" face	Ruby 80	\$23.05	-	\$20.75
GG-9	05G-CWH2009	6" 5/8" x 1-1/4" x 7/16" hole x 3/8" face	Ruby 60	\$34.35	\$30.95	\$27.85
GG-10	05G-CWH2010	6" 5/8" x 1-1/4" x 7/16" hole x 3/8" face	Ruby 80	\$34.35	\$30.95	\$27.85

Diamond Cup Wheels See Page 180

STYLE NO.	ORDER NO.	SIZE/INCHES	PRICE PER DOZ.
CD-1	05H-COW1001	7/8 x .022 x 1/16 hole	\$1.68
CD-2	05H-COW1002	1 x .022 x 1/16 hole	\$2.16
CD-3	05H-COW1003	1 x 1/16 x 1/8 hole	\$5.88
CD-4	05H-COW1004	1 x 3/32 x 1/8 hole	\$6.84
CD-5	05H-COW1005	1 x 1/8 x 1/8 hole	\$6.84
CD-6	05H-COW1006	1-1/2 x 1/64 x 1/8 hole	\$7.20
CD-7	05H-COW1007	1-1/2 x 1/32 x 1/8 hole	\$7.20
CD-8	05H-COW1008	1-1/2 x 1/16 x 1/8 hole	\$7.20
CD-9	05H-COW1009	1-1/2 x 3/32 x 1/8 hole	\$11.88
CD-10	05H-COW1010	1-1/2 x 1/8 x 1/8 hole	\$11.88
CD-11	05H-COW1011	2 x 1/32 x 1/8 hole	\$14.28
CD-12	05H-COW1012	2 x 1/16 x 1/8 hole	\$14.28
CD-13	05H-COW1013	2 x 3/32 x 1/8 hole	\$16.68
CD-14	05H-COW1014	2 x 1/8 x 1/8 hole	\$16.68
CD-15	05H-COW1015	2 x 1/4 x 1/4 hole	\$74.64

For Mandrels, see page 226

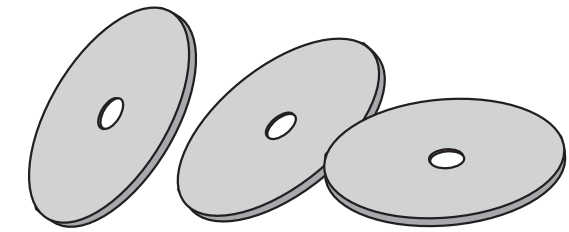

Reinforced Cut-Off Wheels

ORDER NO.	SIZE/INCHES	PRICE PER DOZ.
05H-COW2000	1-1/4 x 3/64 x 1/16" Hole	\$21.00
05H-COW2001	2-1/2 x 3/64 x 1/8" Hole	\$21.00
05H-COW2002	1-1/2 x 1/16 x 1/8" Hole	\$21.84

QUANTITY DISCOUNTS

10 DOZEN, ALL SAME ORDER NO. 10%

Falcon Dressing Sticks for Mounted Points & Wheels

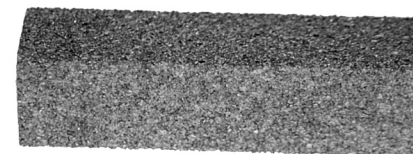

STYLE NO.	ORDER NO.	SIZE/INCHES	PRICE EACH
1032	05I-DRS1032	1/2 x 1/2 x 4	\$2.90
1035	05I-DRS1035	1 x 1/2 x 4	\$3.20
1040	05I-DRS1040	1 x 1 x 4	\$3.75

QUANTITY DISCOUNTS 12 SAME 15%



Diamond Compound

Falcon Diamond Compound is the ultimate polishing medium. Diamond is the hardest material by a large margin and therefore cuts all other materials with ease.



All grades (except 1/2) are available in heavy (100% diamond concentration), standard (75% concentration) and medium light (50% concentration) of diamond.

All diamond compounds are water and oil soluble and supplied in disposable 5 gram and 18 gram plastic applicators.

QUANTITY DISCOUNTS 4 OR MORE OF THE SAME 10%

Table with columns: GRADE NUMBER & CONCENTRATION, 5 GRAM ORDER NO., 18 GRAM ORDER NO., COLOR OF COMPOUND, MESH SIZE EQUIVALENT, 5 GRAM PRICE PER CARTRIDGE, 18 GRAM PRICE PER CARTRIDGE, MICRON RANGE, TYPE OF WORK.

Falcon Diamond Thinner



THINS, COOLS, LUBRICATES

- Developed especially for Falcon Diamond Compounds
Penetrates quickly
Lubricates every diamond particle for maximum cutting action
Helps flush away abraded material
Reduces lapping time
Also used as an excellent stoning oil

Table with columns: SIZE, ORDER NO., PRICE. Rows for 6 oz, 1 Pint, 1 Quart, 1 Gallon.

Wood Sticks

Made of select balsa (very soft) and white birch (soft). Very soft sticks are used for final finishing with diamond or other compounds.

Table with columns: TYPE, SIZE, STICKS PER PACK, ORDER NO., PRICE/PKG. Rows for Very Soft, Soft, Set.

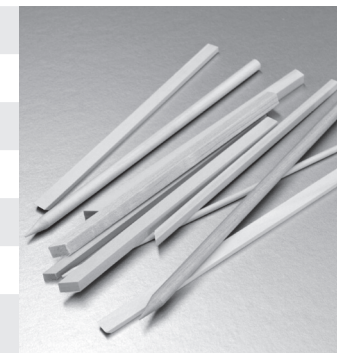

Diamond Slot File

Diamond one side 5-1/4" overall x .160 wide x .008 thick • 50 Micron • Fine



SHAPE NO. 8601 ORDER NO. 07Z-MSC1000 \$17.95

Diamond Escapement File

Smaller than needle files

5-1/2" Overall • Diamond Length 1-5/8" • Square Handle



Table with columns: SHAPE, SHAPE NO., ORDER NO., PRICE, FINE: 50 MICRONS, MEDIUM: 100 MICRONS. Rows for Crossing, Barrette, 3-Square, Equalling, Square, Round.

QUANTITY DISCOUNTS 1 DOZEN OF THE SAME 10% 3 DOZEN OF THE SAME 15%



Diamond Needle Files with Round Handles

1/8" Shank • 5-1/2" Overall • Diamond Length 2-3/4"

EQUALLING	8401		
HALF ROUND	8402		
CROSSING	8403		
KNIFE	8405		
WARDING	8406		
3-SQUARE	8407		
SQUARE	8408		
ROUND	8410		
BARRETTE	8411		
SLITTING	8413		
CROCHET	8416		

SHAPE	SHAPE NO.	FINE: 50 MICRONS		MEDIUM: 100 MICRONS		MEDIUM: 100 MICRONS	
		ORDER NO.	PRICE	ORDER NO.	PRICE	ORDER NO.	PRICE
Equalling	8401	07C-DNF1000	\$21.25	07C-DNF2000	\$26.60	07C-DNF3000	\$34.45
Half Round	8402	07C-DNF1001	\$17.15	07C-DNF2001	\$19.05	07C-DNF3001	\$27.30
Crossing	8403	07C-DNF1002	\$16.95	07C-DNF2002	\$21.80	07C-DNF3002	\$27.05
Knife	8405	07C-DNF1003	\$16.95	07C-DNF2003	\$21.25	07C-DNF3003	\$26.60
Warding	8406	07C-DNF1004	\$19.05	07C-DNF2004	\$23.00	07C-DNF3004	\$28.40
3-Square	8407	07C-DNF1005	\$15.95	07C-DNF2005	\$20.80	07C-DNF3005	\$24.55
Square	8408	07C-DNF1006	\$15.40	07C-DNF2006	\$19.05	07C-DNF3006	\$23.00
Round	8410	07C-DNF1007	\$15.40	07C-DNF2007	\$19.05	07C-DNF3007	\$23.00
Barrette	8411	07C-DNF1008	\$16.70	07C-DNF2008	\$19.05	07C-DNF3008	\$22.55
Slitting	8413	07C-DNF1009	\$16.15	07C-DNF2009	\$20.45	07C-DNF3009	\$24.75
Crochet	8416	07C-DNF1010	\$21.25	07C-DNF2010	\$26.60	07C-DNF3010	\$33.65

Needle Taper Diamond Files

Falcon needle taper diamond files are precision manufactured with the highest quality diamond allowing mold and die polishers easy access in difficult areas like ribs and slots. All Needle Taper Diamond Files have plastic handles. Coarse: 150 Microns

	SIZE (mm)	140 GRIT	200 GRIT	320 GRIT	PRICE
	0.5 x 1 x 130	-	-	07N-NTF3000	\$5.89 ea.
	0.5 x 3 x 130	07N-NTF1001	07N-NTF2001	07N-NTF3001	\$5.89 ea.
	0.5 x 5 x 130	07N-NTF1002	07N-NTF2002	07N-NTF3002	\$5.89 ea.
	0.5 x 7 x 130	07N-NTF1003	07N-NTF2003	07N-NTF3003	\$5.89 ea.



07N-KIT9000 \$58.00

Needle Taper Diamond File Assortment Set

Set includes 1 of each of the following:

- 0.5 x 1 x 130mm, 320 grit
- 0.5 x 3 x 130mm, 140, 200 & 320 grit
- 0.5 x 5 x 130mm, 140, 200 & 320 grit
- 0.5 x 7 x 130mm, 140, 200 & 320 grit

10 Files Total

QUANTITY DISCOUNTS

1 DOZEN OF THE SAME 10%

3 DOZEN OF THE SAME 15%

Diamond Tip Lapper Files

Specifically designed for use in high speed, short stroke profilers. Falcon Diamond Tip Lapper Files have a unique design which locks the file in place. Precisely manufactured from the highest quality diamond they are excellent for hard to reach ribs and slots and detail areas.

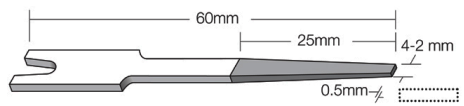
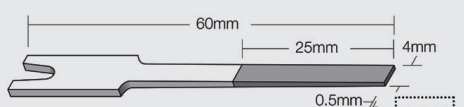
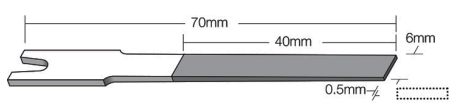
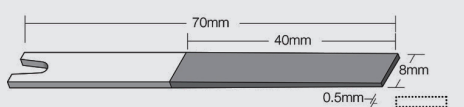
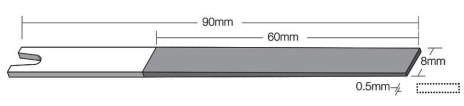
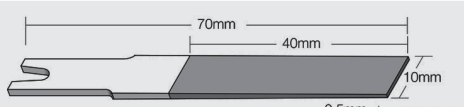
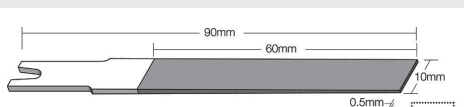
	SIZE (mm)	120 GRIT	150 GRIT	200 GRIT	PRICE
	0.5 x 4-2 x 60	07Q-DTF3000	07Q-DTF2000	07Q-DTF1000	\$6.75 ea.
	0.5 x 4 x 60	07Q-DTF3001	07Q-DTF2001	07Q-DTF1001	\$6.75 ea.
	0.5 x 6 x 70	07Q-DTF3002	07Q-DTF2002	07Q-DTF1002	\$6.75 ea.
	0.5 x 8 x 70	07Q-DTF3003	07Q-DTF2003	07Q-DTF1003	\$6.75 ea.
	0.5 x 8 x 90	07Q-DTF3004	07Q-DTF2004	07Q-DTF1004	\$6.75 ea.
	0.5 x 10 x 70	07Q-DTF3005	07Q-DTF2005	07Q-DTF1005	\$6.75 ea.
	0.5 x 10 x 90	07Q-DTF3006	07Q-DTF2006	07Q-DTF1006	\$6.75 ea.

Diamond Tip Lapper File Assortment Set

Set includes 1 of each of the following:

- 0.5 x 4-2 x 60mm, 150, 200 & 400 grit
- 0.5 x 4 x 60mm, 150, 200 & 400 grit
- 0.5 x 6 x 70mm, 150 & 200 grit
- 0.5 x 8 x 70mm, 150 & 200 grit
- 0.5 x 10 x 70mm, 150 & 200 grit

12 Files Total



07Q-KIT9000
\$75.00

Diamond Files for Die Profiling Machines, 1/8" Shank

Overall length 2" • Diamond Section 5/8" long

*Overall length 2-3/8" • Diamond Section 1" long



Cuts One Side, Safe Three Sides

SHAPE NO.	SHAPE	APPROX. SIZE		FINE: 50 MICRONS		MEDIUM: 100 MICRONS		COARSE: 150 MICRONS	
		WIDTH	THICK	ORDER NO.	PRICE	ORDER NO.	PRICE	ORDER NO.	PRICE
8301	Flat One Side	.079	.039	07F-DDP1000	\$4.85	07F-DDP2000	\$5.65	07F-DDP3000	\$6.60
8303	Flat One Side	.118	.039	07F-DDP1001	\$5.15	07F-DDP2001	\$5.95	07F-DDP3001	\$6.90
8305	Flat One Side	.157	.039	07F-DDP1002	\$5.40	07F-DDP2002	\$6.15	07F-DDP3002	\$7.20
8307	Flat One Side	.197	.079	07F-DDP1003	\$6.00	07F-DDP2003	\$6.95	07F-DDP3003	\$7.85
8309*	Flat One Side	.197	.079	07F-DDP1004	\$7.75	07F-DDP2004	\$9.45	07F-DDP3004	\$11.25

Cuts Two Sides • Safe Two Edges

SHAPE NO.	SHAPE	APPROX. SIZE		FINE: 50 MICRONS		MEDIUM: 100 MICRONS		COARSE: 150 MICRONS	
		WIDTH	THICK	ORDER NO.	PRICE	ORDER NO.	PRICE	ORDER NO.	PRICE
8310	Flat Two Sides	.079	.039	07F-DDP1005	\$7.30	07F-DDP2005	\$8.65	07F-DDP3005	\$9.60
8311	Flat Two Sides	.118	.039	07F-DDP1006	\$7.75	07F-DDP2006	\$9.05	07F-DDP3006	\$10.55
8312	Flat Two Sides	.157	.039	07F-DDP1007	\$8.65	07F-DDP2007	\$9.85	07F-DDP3007	\$11.50
8313	Flat Two Sides	.197	.079	07F-DDP1008	\$9.60	07F-DDP2008	\$11.10	07F-DDP3008	\$12.55
8314*	Flat Two Sides	.197	.079	07F-DDP1009	\$12.40	07F-DDP2009	\$15.10	07F-DDP3009	\$18.00

Round

SHAPE NO.	SHAPE	APPROX. SIZE		FINE: 50 MICRONS		MEDIUM: 100 MICRONS		COARSE: 150 MICRONS	
		WIDTH	THICK	ORDER NO.	PRICE	ORDER NO.	PRICE	ORDER NO.	PRICE
8331	Round	.039	—	07F-DDP1014	\$5.40	07F-DDP2014	\$5.65	07F-DDP3014	\$5.90
8335	Round	.079	—	07F-DDP1015	\$5.90	07F-DDP2015	\$6.90	07F-DDP3015	\$7.85
8337*	Round	.079	—	07F-DDP1016	\$8.10	07F-DDP2016	\$9.65	07F-DDP3016	\$11.05

Half Round

SHAPE NO.	SHAPE	APPROX. SIZE		FINE: 50 MICRONS		MEDIUM: 100 MICRONS		COARSE: 150 MICRONS	
		WIDTH	THICK	ORDER NO.	PRICE	ORDER NO.	PRICE	ORDER NO.	PRICE
8395	Half-Round	.039	—	07F-DDP1038	\$7.40	07F-DDP2038	\$8.05	07F-DDP3038	\$9.60
8397	Half-Round	.059	—	07F-DDP1039	\$9.00	07F-DDP2039	\$9.60	07F-DDP3039	\$11.65
8399	Half-Round	.079	—	07F-DDP1040	\$10.05	07F-DDP2040	\$11.45	07F-DDP3040	\$13.50

QUANTITY DISCOUNTS 2 DOZEN OF THE SAME 5% 6 DOZEN OF THE SAME 10%



Diamond Machine Files for Reciprocating Profilers, 3mm Shank

Machine diamond files are precision manufactured with the highest quality diamond for use in reciprocating hand-pieces. All with 3mm shanks.

\$7.00 each

SIZE (mm)	150 GRIT	SIZE (mm)	150 GRIT
	1 x 3 x 50mm, 1-side 07P-DDP4000		2 x 50mm, TRI 3-sides 07P-DDP4013
	1.8 x 5 x 50mm, 1-side 07P-DDP4001		3 x 50mm, TRI 3-sides 07P-DDP4014
	1 x 2 x 50mm, 1-side 07P-DDP4002		4 x 50mm, TRI 3-sides 07P-DDP4015
	1 x 4 x 50mm, 1-side 07P-DPP4003		1 x 4 x 50mm, TRI 3-sides 07P-DDP4016
	2 x 5 x 50mm, 1-side 07P-DDP4004		1 x 50mm, Half Round 07P-DDP4017
	1 x 3 x 50mm, 2-sides 07P-DDP4005		1.5 x 50mm, Half Round 07P-DDP4018
	1 x 2 x 50mm, 2-sides 07P-DDP4006		2 x 50mm, Half Round 07P-DDP4019
	.08 x 3 x 50mm, 2-sides 07P-DDP4007		1 x 50mm, Round 07P-DDP4020
	1 x 3 x 50mm, 2-sides 07P-DDP4008		2 x 50mm, Round 07P-DDP4021
	1.4 x 3 x 50mm, 4-sides 07P-DDP4009		3 x 50mm, Round 07P-DDP4022
	1.4 x 5.6 x 50mm, 4-sides 07P-DDP4010		4 x 50mm, Round 07P-DDP4023
	2 x 2 x 50mm, 4-sides 07P-DDP4011		2.3 x 3.5 x 50mm, Ellipse 07P-DDP4024
	3 x 3 x 50mm, 4-sides 07P-DDP4012		

Interchangeable File Handles

Holds any 1/8" Shank Tool

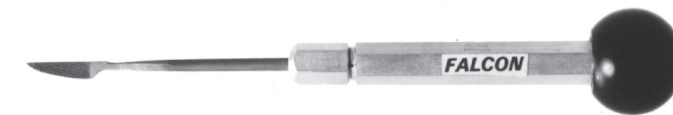

NUMBER IF-20 ORDER NO. 01Z-MSC1100 \$4.65

Diamond Hones, Diamond Concentration 100

Diamond Insert Two Ends

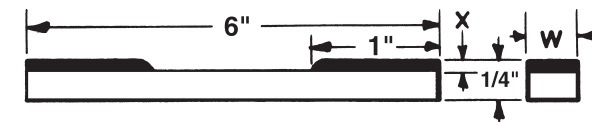

STYLE NO.	ORDER NO.	SIZE (INCHES)		PRICE
		W	X	
207	07I-DHN1004	1/4	1/32	\$51.85
207A	07I-DHN1005	1/4	1/16	\$64.20
209	07I-DHN1006	3/8	1/32	\$58.00
209A	07I-DHN1007	3/8	1/16	\$76.70

Standard grit 150 one end, 320 opposite end

Diamond Wheel Dressing Stick



STYLE NO.	ORDER NO.	SIZE (INCHES)	PRICE EACH	PRICE DOZ.
DS-80	07Z-MSC1200	1/2 x 1/2 x 6	\$3.30	\$33.66

Soft aluminum oxide abrasive for cleaning diamond wheels to re-expose the diamond particles.



- Diamond Wheels with 20 mm hole fit Kuhlmann, Deckel and Hasberg Cutter Grinders
- Additional hole sizes are available to fit Gorton and other cutter grinders. Please specify Falcon Order No., quantity and hole size required
- 120 Grit Resin Bond for Wet or Dry Grinding Supplied as Standard
- Always wear proper eye protection while using rotary power tool accessories
- Diamond Wheels can be cleaned and dressed by lightly grinding a soft aluminum oxide dressing stick of 60-80 grit

Flaring Cup – Diamond in Rim

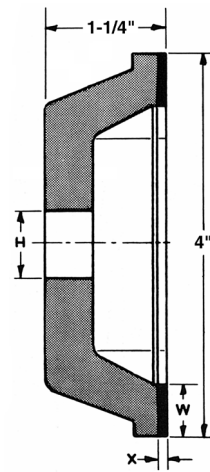

Type 11A2

STYLE NO.	ORDER NO.	SIZE (INCHES)			DIAMOND CONC.	PRICE EACH
		H	W	X		
DW-23	07J-DCW1023	20 mm	1/4	1/16	100	\$118.55
DW-24	07J-DCW1024	20 mm	1/4	1/8	100	\$190.20
DW-25	07J-DCW1025	20 mm	1/4	1/16	50	\$81.30
DW-26	07J-DCW1026	20 mm	1/4	1/8	50	\$118.35
DW-27	07J-DCW1027	20 mm	1/2	1/16	100	\$196.80
DW-28	07J-DCW1028	20 mm	1/2	1/8	100	\$342.35
DW-29	07J-DCW1029	20 mm	1/2	1/16	50	\$124.65
DW-30	07J-DCW1030	20 mm	1/2	1/8	50	\$196.80

Flaring Cup – Diamond in Periphery

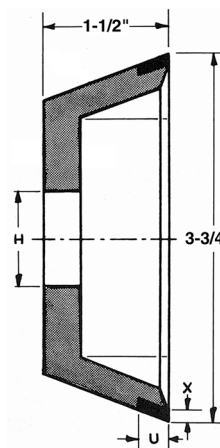

Type 11V9

STYLE NO.	ORDER NO.	SIZE (INCHES)			DIAMOND CONC.	PRICE EACH
		H	U	X		
DW-31	07J-DCW1031	20 mm	3/8	1/16	100	\$165.85
DW-32	07J-DCW1032	20 mm	3/8	1/8	100	\$272.60
DW-33	07J-DCW1033	20 mm	3/8	1/16	50	\$110.40
DW-34	07J-DCW1034	20 mm	3/8	1/8	50	\$163.80

Diamond Points & Wheels

All on 3/32" Shank, Pictures are actual size

MAXIMUM RPM

BM-17	250,000
BM-9, 18, 23, 28, 29, 30	120,000
BM-6, 7, 10, 11, 22, 24, 26, 27, 31	80,000
BM-1, 4, 13, 33, 39	60,000
BM-3	40,000

STYLE NO.	BM-1	BM-3	BM-4	BM-6	BM-7	BM-9	BM-10
ORDER NO.	07L-DPW1001	07L-DPW1003	07L-DPW1004	07L-DPW1006	07L-DPW1007	07L-DPW1009	07L-DPW1010
PRICE	\$19.00	\$16.80	\$16.80	\$10.10	\$13.95	\$12.25	\$12.25

STYLE NO.	BM-11	BM-13	BM-17	BM-18	BM-22	BM-23	BM-24
ORDER NO.	07L-DPW1011	07L-DPW1013	07L-DPW1017	07L-DPW1018	-	07L-DPW1023	07L-DPW1024
PRICE	\$23.40	\$27.10	\$13.25	\$13.25	-	\$16.60	\$13.25

STYLE NO.	BM-26	BM-27	BM-28	BM-29	BM-30	BM-31	BM-33	BM-39
ORDER NO.	07L-DPW1026	07L-DPW1027	07L-DPW1028	07L-DPW1029	07L-DPW1030	07L-DPW1031	-	07L-DPW1039
PRICE	\$23.40	\$27.60	\$10.10	\$15.65	\$13.95	\$17.55	-	\$17.50

Precision Diamond Wheels for Jig and Internal Grinding

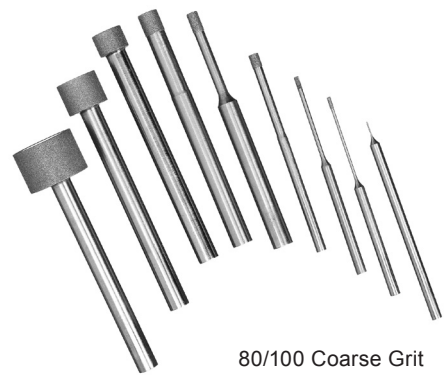

80/100 Coarse Grit
200/240 Fine Grit
All dimensions in inches

These mandrels feature hardened steel shanks and multi-layer diamond coated surfaces. The diamond particles are bonded onto the mandrel through the "Electrogrip" process, which maximizes diamond particle exposure assuring a free cutting action which greatly reduces heat and wear.

These mandrels, when used properly, consistently outperform conventional single layer diamond mandrels!

RECOMMENDED SPEEDS

.020 - .200 dia	60,000 - 120,000 RPM
.200 - .500 dia	45,000 - 60,000 RPM
.500 - 1.00 dia	30,000 - 45,000 RPM

"PD" Series

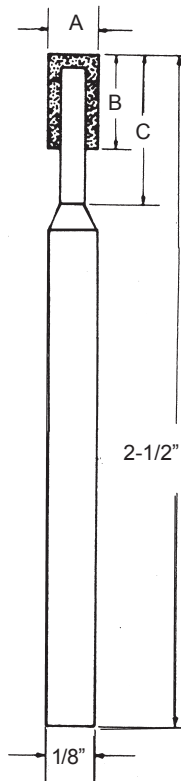

DIAMOND GRIT SIZES	STYLE NO.	ORDER NO. GRIT SIZES 200/240	ORDER NO. GRIT SIZES 80/100	A ±0.0015 (INCHES)	B ±0.0010 (INCHES)	C ±0.0005 (INCHES)	PRICE EACH
200/240	PD-1	07H-PDW1001	-	.020	1/16	1/8	\$8.05
	PD-2	07H-PDW1002	-	.025	3/32	1/4	\$7.20
	PD-3	07H-PDW1003	-	.030	3/32	1/4	\$7.20
	PD-4	07H-PDW1004	-	.035	3/32	1/4	\$7.20
200/240 or 80/100	PD-5	07H-PDW1005	-	.040	1/8	3/8	\$7.20
	PD-7	07H-PDW1007	07H-PDW2007	.050	1/8	3/8	\$7.40
200/240 or 80/100	PD-9	07H-PDW1009	-	.055	1/8	3/8	\$7.60
	PD-10	-	07H-PDW2010	.060	1/8	3/8	\$7.35
	PD-11	07H-PDW1011	-	.060	1/8	1	\$8.95
200/240 or 80/100	PD-14	07H-PDW1014	07H-PDW2014	.080	5/32	1/2	\$8.35
	PD-17	07H-PDW1017	-	.090	5/32	1	\$9.25
200/240 or 80/100	PD-20	-	07H-PDW2020	.110	5/32	1/2	\$8.60
	PD-22	07H-PDW1022	07H-PDW2022	.125	5/32	1/2	\$9.05
200/240 or 80/100	PD-23	07H-PDW1023	07H-PDW2023	.125	5/32	1	\$9.90

QUANTITY DISCOUNTS	12+ OF THE SAME 2.5%	24+ OF THE SAME 5%
	72+ OF THE SAME 7.5%	144+ OF THE SAME 10%

200/240 Fine Grit • 150/170 Medium Grit • 80/100 Coarse Grit

"P" Series

DIAMOND GRIT SIZES	STYLE NO.	ORDER NO. GRIT SIZES 200/240	ORDER NO. GRIT SIZES 80/100	A ±0.0015 (INCHES)	B ±0.0010 (INCHES)	C ±0.0005 (INCHES)	PRICE EACH
200/240	P-101	07H-PDW3101	-	.020	1/16	1/8	\$8.35
	P-102	07H-PDW3102	-	.025	3/32	1/4	\$8.30
	P-103	07H-PDW3103	-	.030	3/32	1/4	\$8.30
	P-104	07H-PDW3104	-	.035	3/32	1/4	\$8.30
200/240 or 80/100	P-105	07H-PDW3105	07H-PDW4105	.040	1/8	3/8	\$8.30
	P-107	-	07H-PDW4107	.050	1/8	3/8	\$8.05
200/240 or 80/100	P-109	07H-PDW3109	07H-PDW4109	.060	1/8	3/8	\$7.80
	P-110	07H-PDW3110	-	.070	5/32	1/2	\$7.95
	P-111	-	07H-PDW4111	.080	5/32	1/2	\$8.30
	P-112	-	07H-PDW4112	.090	5/32	1/2	\$8.40
	P-113	-	07H-PDW4113	.100	5/32	1/2	\$8.50
200/240 or 80/100	P-115	07H-PDW3115	07H-PDW4115	.125	5/32	1/2	\$9.05

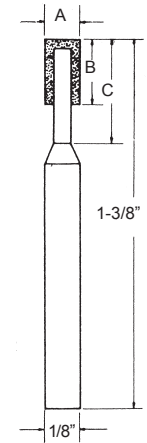

"PW" Series

DIAMOND GRIT SIZES	STYLE NO.	ORDER NO. GRIT SIZES 150/170	ORDER NO. GRIT SIZES 80/100	A (INCHES)	B (INCHES)	PRICE EACH
150/170 or 80/100	PW-206	07H-PDW5206	07H-PDW6206	1/4	1/4	\$14.25
	PW-208	-	07H-PDW6208	5/16	1/4	\$20.35
150/170 or 80/100	PW-211	-	07H-PDW6211	3/8	1/4	\$20.35
	PW-212	07H-PDW5212	07H-PDW6212	3/8	3/8	\$24.40

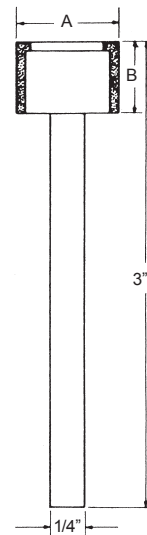

QUANTITY DISCOUNTS	12+ OF THE SAME 2.5%	24+ OF THE SAME 5%
	72+ OF THE SAME 7.5%	144+ OF THE SAME 10%

Phono Points

1/8" Shank • 1" Overall



ANGLE	90°	75°	60°
ORDER NO.	07M-PPT1090	07M-PPT1075	07M-PPT1060
PRICE	\$8.50	\$9.50	\$9.80



Falcon MX Finishing Wheels, MX Sticks

Especially Fine for Polishing Runners on Plastic Molds and Dies

MX is a cotton fiber abrasive and is the result of laminating non-woven cotton fiber with aluminum oxide grain and bonded to achieve varying characteristics. MX is acceptable for use on both ferrous and non-ferrous materials and works extremely well on stainless steel. It is very quiet and smooth running. Its special composition runs cool with virtually no loading. This non-loading makes it extremely suitable for working with softer metals and alloys, such as aluminum.

- 1/8" & 1/4" Shanks • Standard Grit: 120 • Other Grits: 50, 80, 180, 320

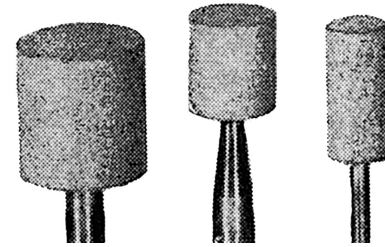

Table with columns: SHAPE NO., SIZE (IN) (D X L), SHANK, MAX RPM, GRIT 50, GRIT 80, GRIT 120, GRIT 180, GRIT 320, PRICE EACH. Lists various MX wheel and stick models and their specifications.

QUANTITY DISCOUNTS

100+ SAME SIZE & GRIT 10%

500+ SAME SIZE & GRIT 15%

Abrasive Shop Rolls • Aluminum Oxide

50 yards per roll

Table with columns: GRIT, ORDER NO., PRICE, 1" WIDTH, 1-1/2" WIDTH, 2" WIDTH. Lists various abrasive shop roll models and their prices.



QUANTITY DISCOUNTS

10 SAME ROLLS 5%

25 SAME ROLLS 10%

Abrasive Cloth Sheets Aluminum Oxide

50 sheets per package

Table with columns: GRIT, SHEET SIZE, PRICE. Lists various abrasive cloth sheet models and their prices.

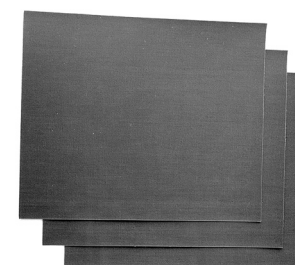

Waterproof Paper Silicon Carbide

50 sheets per package

Table with columns: GRIT, SHEET SIZE, PRICE. Lists various waterproof paper silicon carbide models and their prices.



QUANTITY DISCOUNTS

10 SAME PACKAGE 5%

25 SAME PACKAGE 10%



Clover Lapping Compound

1 lb. Can (Silicon Carbide Abrasive)

Grease mix abrasive for cutting, smoothing and finishing of metal surfaces, and for the precision mating of metal parts.



GRADE	ORDER NO.	GRIT	PRICE EACH
J	08E-PBC1000	50	\$28.20
G	08E-PBC1001	80	\$28.20
F	08E-PBC1002	100	\$28.20
E	08E-PBC1003	120	\$28.20
NC	08E-PBC1004	150	\$28.20
D	08E-PBC1005	180	\$28.20
C	08E-PBC1006	220	\$28.20
B	08E-PBC1007	240	\$28.20
A	08E-PBC1008	280	\$28.20
1A	08E-PBC1009	320	\$34.10
2A	08E-PBC1010	400	\$34.10
3A	08E-PBC1011	500	\$34.10
4A	08E-PBC1012	600	\$52.60
5A	08E-PBC1013	800	\$52.60
6A	08E-PBC1014	1000	\$52.60

Lea Compound in Air Tight Tubes

Greaseless abrasive composition for deburring, buffing, polishing and satin finishing.



GRADE	ORDER NO.	GRIT	PRICE EACH
B	08E-PBC3001	150	\$8.05

Simichrome Polish

Removes tarnish, dirt and oils, and generally renews polished metal surfaces while leaving a protective film which retards oxidation. Simichrome works well on brass, bronze, chromium, and aluminum and is recommended for use after diamond compound. It can be rubbed on and removed with a soft cloth; or it can be used with a clean felt bob. Available in 50gm tubes and 250gm tins.

ORDER NO.	SIZE	PRICE
08E-POL1000	50 gm Tube	\$9.75 ea.
08E-POL1001	250 gm Tin	\$34.00 ea.

Abrasive Finishing Compound

1 lb. Squeeze Bottles (Water and Oil Soluble)



SILICON CARBIDE			ALUMINUM OXIDE	
GRIT	ORDER NO.	PRICE	ORDER NO.	PRICE
120	08E-PBC2000	\$22.05	—	—
220	08E-PBC2001	\$24.40	08E-PBC2501	\$24.40
400	08E-PBC2002	\$28.60	08E-PBC2502	\$25.75
600	08E-PBC2003	\$32.30	08E-PBC2503	\$34.00

Silicon Carbide Grain

1 lb. Can



GRIT	ORDER NO.	PRICE EACH
220	08E-PBC4000	\$5.10
320	08E-PBC4001	\$8.50
400	08E-PBC4002	\$9.80
500	08E-PBC4003	\$11.60
600	08E-PBC4004	\$14.55

Aluminum Oxide Grain

1 lb. Can

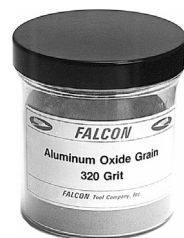

GRIT	ORDER NO.	PRICE EACH
320	08E-PBC5001	\$5.50
400	08E-PBC5002	\$5.75
500	08E-PBC5003	\$6.65
600	08E-PBC5004	\$8.25



For Muslin Buffs, see page 98. For Felt Bobs, see page 101 & 102.

Glue Bond Abrasive Cartridge Rolls Aluminum Oxide

Falcon Cartridge Rolls are ideal for finishing operations on inside diameters, dead-end holes, and lapping operations. Their self-renewing features of wearing through one layer of abrasive cloth to uncover the layer beneath makes them an excellent tool for blending where high finishes are required. They are available in a wide range of sizes and grits for every kind of application. Note: Use proper eye protection. Prices per 100, packed 100 per package; sold in full packages of 100 only.

Size No. 30 • Diameter: 1/8" • Center Hole: 5/64"

GRIT	3/4" ROLL LENGTH		1" ROLL LENGTH	
	ORDER NO.	PRICE	ORDER NO.	PRICE
80	08F-CTR1000	\$25.00	08F-CTR2000	\$26.00
100	08F-CTR1001	\$25.00	08F-CTR2001	\$26.00
120	08F-CTR1002	\$25.00	08F-CTR2002	\$26.00
150	08F-CTR1003	\$25.00	08F-CTR2003	\$26.00
180	08F-CTR1004	\$25.00	08F-CTR2004	\$26.00
240	08F-CTR1005	\$25.00	08F-CTR2005	\$26.00
320	08F-CTR1006	\$25.00	08F-CTR2006	\$26.00

Size No. 31 • Diameter: 3/16" • Center Hole: 3/32"

GRIT	3/4" ROLL LENGTH		1" ROLL LENGTH	
	ORDER NO.	PRICE	ORDER NO.	PRICE
80	08F-CTR1100	\$25.00	08F-CTR2100	\$26.00
100	08F-CTR1101	\$25.00	08F-CTR2101	\$26.00
120	08F-CTR1102	\$25.00	08F-CTR2102	\$26.00
150	08F-CTR1103	\$25.00	08F-CTR2103	\$26.00
180	08F-CTR1104	\$25.00	08F-CTR2104	\$26.00
240	08F-CTR1105	\$25.00	08F-CTR2105	\$26.00
320	08F-CTR1106	\$25.00	08F-CTR2106	\$26.00

Size No. 32 • Diameter: 1/4" • Center Hole: 1/8"

GRIT	3/4" ROLL LENGTH		1" ROLL LENGTH		1-1/2" Roll Length	
	ORDER NO.	PRICE	ORDER NO.	PRICE	ORDER NO.	PRICE
60	08F-CTR1200	\$26.00	08F-CTR2200	\$27.00	08F-CTR3200	\$32.00
80	08F-CTR1201	\$26.00	08F-CTR2201	\$27.00	08F-CTR3201	\$32.00
100	08F-CTR1202	\$26.00	08F-CTR2202	\$27.00	08F-CTR3202	\$32.00
120	08F-CTR1203	\$26.00	08F-CTR2203	\$27.00	08F-CTR3203	\$32.00
150	08F-CTR1204	\$26.00	08F-CTR2204	\$27.00	08F-CTR3204	\$32.00
180	08F-CTR1205	\$26.00	08F-CTR2205	\$27.00	08F-CTR3205	\$32.00
240	08F-CTR1206	\$26.00	08F-CTR2206	\$27.00	08F-CTR3206	\$32.00
320	08F-CTR1207	\$26.00	08F-CTR2207	\$27.00	08F-CTR3207	\$32.00

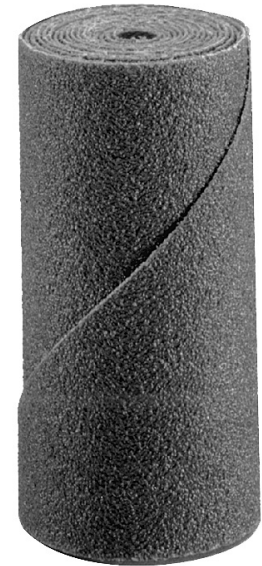

RECOMMENDED RPM

Diameter	RPM
1/8" - 1/2"	16,000-22,000
5/8" - 1"	12,000-18,000
1" - 1-1/2"	10,000-15,000

Coarser grit and slower speed removes more material.

Finer grit and faster speed produces a finer finish.

QUANTITY DISCOUNTS

- 5 SAME PACKAGE 5%
- 10 SAME PACKAGE 8%
- 25 SAME PACKAGE 10%



Glue Bond Abrasive Cartridge Rolls Aluminum Oxide

Prices per 100, packed 100 per package; sold in full packages of 100 only.

Size No. 33 • Diameter: 5/16" • Center Hole: 1/8"

Table with 7 columns: GRIT, ORDER NO., PRICE, 3/4" ROLL LENGTH, 1" ROLL LENGTH, 1-1/2" Roll Length, PRICE. Rows include grits 40, 50, 60, 80, 100, 120, 150, 180, 240, 320.

Size No. 34 • Diameter: 3/8" • Center Hole: 1/8"

Table with 7 columns: GRIT, ORDER NO., PRICE, 3/4" ROLL LENGTH, 1" ROLL LENGTH, 1-1/2" Roll Length, PRICE. Rows include grits 40, 50, 60, 80, 100, 120, 150, 180, 240, 320.

Size No. 35 • Diameter: 1/2" • Center Hole: 1/8"

Table with 7 columns: GRIT, ORDER NO., PRICE, 3/4" ROLL LENGTH, 1" ROLL LENGTH, 1-1/2" Roll Length, PRICE. Rows include grits 40, 50, 60, 80, 100, 120, 150, 180, 240, 320.

QUANTITY DISCOUNTS

- 5 SAME PACKAGE 5%
10 SAME PACKAGE 8%
25 SAME PACKAGE 10%

Glue Bond Abrasive Cartridge Rolls Aluminum Oxide

Prices per 100, packed 100 per package; sold in full packages of 100 only.

Size No. 36 • Diameter: 5/8" • Center Hole: 3/16"

Table with 7 columns: GRIT, ORDER NO., PRICE, 3/4" ROLL LENGTH, 1" ROLL LENGTH, 1-1/2" Roll Length, PRICE. Rows include grits 40, 50, 60, 80, 100, 120, 150, 180, 240, 320.

Size No. 37 • Diameter: 3/4" • Center Hole: 1/4"

Table with 7 columns: GRIT, ORDER NO., PRICE, 3/4" ROLL LENGTH, 1" ROLL LENGTH, 1-1/2" Roll Length, PRICE. Rows include grits 40, 50, 60, 80, 100, 120, 150, 180, 240, 320.

Size No. 38 • Diameter: 1" • Center Hole: 1/4"

Table with 7 columns: GRIT, ORDER NO., PRICE, 3/4" ROLL LENGTH, 1" ROLL LENGTH, 1-1/2" Roll Length, PRICE. Rows include grits 40, 50, 60, 80, 100, 120, 150, 180, 240, 320.

QUANTITY DISCOUNTS

- 5 SAME PACKAGE 5%
10 SAME PACKAGE 8%
25 SAME PACKAGE 10%



Resin Bond Abrasive Cartridge Rolls Aluminum Oxide

Where faster cutting and utmost economy are required, we recommend Falcon Cartridge Rolls made from resin bond abrasive cloth. Resin bond rolls will last up to three times as long as glue bond rolls of similar size and grit — "load" less, run cooler, with less dust. Note: Use proper eye protection. Prices per 100, packed 100 per package; sold in full packages of 100 only.

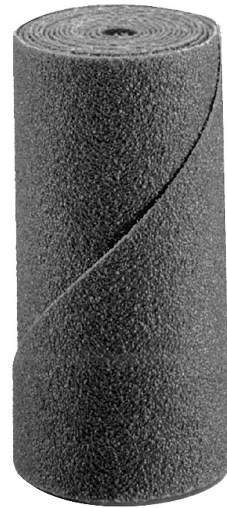

Size No. 30R • Diameter: 1/8" • Center Hole: 5/64"

Table with columns: GRIT, ORDER NO., PRICE, 3/4" ROLL LENGTH, 1" ROLL LENGTH. Rows include grits 80, 100, 120, 150, 180, 240, 320.

Size No. 31R • Diameter: 3/16" • Center Hole: 3/32"

Table with columns: GRIT, ORDER NO., PRICE, 3/4" ROLL LENGTH, 1" ROLL LENGTH. Rows include grits 60, 80, 100, 120, 150, 180, 240, 320.

Size No. 32R • Diameter: 1/4" • Center Hole: 1/8"

Table with columns: GRIT, ORDER NO., PRICE, 3/4" ROLL LENGTH, 1" ROLL LENGTH, 1-1/2" Roll Length. Rows include grits 40, 50, 60, 80, 100, 120, 150, 180, 240, 320.

QUANTITY DISCOUNTS

- 5 SAME PACKAGE 5%
10 SAME PACKAGE 8%
25 SAME PACKAGE 10%

Resin Bond Abrasive Cartridge Rolls Aluminum Oxide

Prices per 100, packed 100 per package; sold in full packages of 100 only.

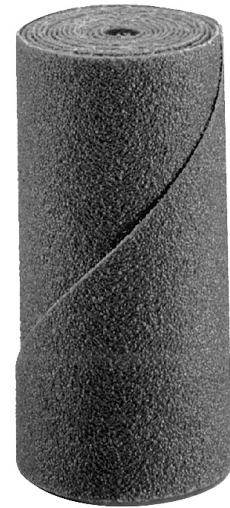

Size No. 33R • Diameter: 5/16" • Center Hole: 1/8"

Table with columns: GRIT, ORDER NO., PRICE, 3/4" ROLL LENGTH, 1" ROLL LENGTH, 1-1/2" Roll Length. Rows include grits 40, 50, 60, 80, 100, 120, 150, 180, 240, 320.

Size No. 34R • Diameter: 3/8" • Center Hole: 1/8"

Table with columns: GRIT, ORDER NO., PRICE, 3/4" ROLL LENGTH, 1" ROLL LENGTH, 1-1/2" Roll Length. Rows include grits 40, 50, 60, 80, 100, 120, 150, 180, 240, 320.

Size No. 35R • Diameter: 1/2" • Center Hole: 1/8"

Table with columns: GRIT, ORDER NO., PRICE, 3/4" ROLL LENGTH, 1" ROLL LENGTH, 1-1/2" Roll Length. Rows include grits 40, 50, 60, 80, 100, 120, 150, 180, 240, 320.

QUANTITY DISCOUNTS

- 5 SAME PACKAGE 5%
10 SAME PACKAGE 8%
25 SAME PACKAGE 10%



**Resin Bond Abrasive Cartridge Rolls
Aluminum Oxide**

Prices per 100, packed 100 per package; sold in full packages of 100 only.



Size No. 36R • Diameter: 5/8" • Center Hole: 3/16"

3/4" ROLL LENGTH			1" ROLL LENGTH		1-1/2" Roll Length	
GRIT	ORDER NO.	PRICE	ORDER NO.	PRICE	ORDER NO.	PRICE
40	08F-CTR4600	\$41.00	08F-CTR5600	\$45.00	08F-CTR6600	\$53.00
50	08F-CTR4601	\$41.00	08F-CTR5601	\$45.00	08F-CTR6601	\$53.00
60	08F-CTR4602	\$41.00	08F-CTR5602	\$45.00	08F-CTR6602	\$53.00
80	08F-CTR4603	\$41.00	08F-CTR5603	\$45.00	08F-CTR6603	\$53.00
100	08F-CTR4604	\$41.00	08F-CTR5604	\$45.00	08F-CTR6604	\$53.00
120	08F-CTR4605	\$41.00	08F-CTR5605	\$45.00	08F-CTR6605	\$53.00
150	08F-CTR4606	\$41.00	—	—	08F-CTR6606	\$53.00
180	08F-CTR4607	\$41.00	08F-CTR5607	\$45.00	08F-CTR6607	\$53.00
240	08F-CTR4608	\$41.00	08F-CTR5608	\$45.00	08F-CTR6608	\$53.00
320	08F-CTR4609	\$41.00	08F-CTR5609	\$45.00	08F-CTR6609	\$53.00

Size No. 37R • Diameter: 3/4" • Center Hole: 1/4"

3/4" ROLL LENGTH			1" ROLL LENGTH		1-1/2" Roll Length	
GRIT	ORDER NO.	PRICE	ORDER NO.	PRICE	ORDER NO.	PRICE
40	08F-CTR4700	\$47.00	08F-CTR5700	\$55.00	08F-CTR6700	\$67.00
50	08F-CTR4701	\$47.00	08F-CTR5701	\$55.00	08F-CTR6701	\$67.00
60	08F-CTR4702	\$47.00	08F-CTR5702	\$55.00	08F-CTR6702	\$67.00
80	08F-CTR4703	\$47.00	08F-CTR5703	\$55.00	08F-CTR6703	\$67.00
100	08F-CTR4704	\$47.00	08F-CTR5704	\$55.00	08F-CTR6704	\$67.00
120	08F-CTR4705	\$47.00	08F-CTR5705	\$55.00	08F-CTR6705	\$67.00
150	08F-CTR4706	\$47.00	08F-CTR5706	\$55.00	08F-CTR6706	\$67.00
180	08F-CTR4707	\$47.00	08F-CTR5707	\$55.00	08F-CTR6707	\$67.00
240	08F-CTR4708	\$47.00	08F-CTR5708	\$55.00	08F-CTR6708	\$67.00
320	08F-CTR4709	\$47.00	08F-CTR5709	\$55.00	08F-CTR6709	\$67.00

Size No. 38R • Diameter: 1" • Center Hole: 1/4"

3/4" ROLL LENGTH			1" ROLL LENGTH	
GRIT	ORDER NO.	PRICE	ORDER NO.	PRICE
40	08F-CTR5800	\$102.00	08F-CTR6800	\$140.00
50	08F-CTR5801	\$102.00	08F-CTR6801	\$140.00
60	08F-CTR5802	\$102.00	08F-CTR6802	\$140.00
80	08F-CTR5803	\$102.00	08F-CTR6803	\$140.00
100	08F-CTR5804	\$102.00	08F-CTR6804	\$140.00
120	08F-CTR5805	\$102.00	08F-CTR6805	\$140.00
150	08F-CTR5806	\$102.00	08F-CTR6806	\$140.00
180	08F-CTR5807	\$102.00	08F-CTR6807	\$140.00
240	08F-CTR5808	\$102.00	08F-CTR6808	\$140.00
320	08F-CTR5809	\$102.00	08F-CTR6809	\$140.00

QUANTITY DISCOUNTS

- 5 SAME PACKAGE 5%
- 10 SAME PACKAGE 8%
- 25 SAME PACKAGE 10%

Pilot Mandrels

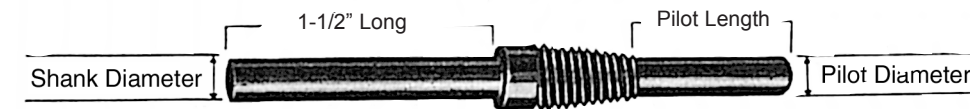

STYLE NO.	ORDER NO.	PILOT DIAMETER	PILOT LENGTH	SHANK DIAMETER	PRICE EACH
PM-1	08G-PLM1001	5/64"	1"	1/8"	\$3.35
PM-2	08G-PLM1002	3/32"	1"	1/8"	\$3.40
PM-3	08G-PLM1003	1/8"	1/2"	1/8"	\$3.45
PM-4	08G-PLM1004	1/8"	3/4"	1/8"	\$3.50
PM-5	08G-PLM1005	1/8"	1"	1/8"	\$3.55
PM-6	08G-PLM1006	1/8"	1/2"	1/4"	\$3.60
PM-7	08G-PLM1007	1/8"	3/4"	1/4"	\$3.65
PM-8	08G-PLM1008	1/8"	1"	1/4"	\$3.70
PM-9	08G-PLM1009	3/16"	1/2"	1/8"	\$3.75
PM-10	08G-PLM1010	3/16"	3/4"	1/8"	\$3.80
PM-11	08G-PLM1011	3/16"	1/2"	1/4"	\$3.85
PM-12	08G-PLM1012	3/16"	3/4"	1/4"	\$3.90
PM-13	08G-PLM1013	3/16"	1"	1/4"	\$3.95
PM-14	08G-PLM1014	1/4"	1/2"	1/4"	\$4.00
PM-15	08G-PLM1015	1/4"	3/4"	1/4"	\$4.05
PM-16	08G-PLM1016	1/4"	1"	1/4"	\$4.10
PM-17	08G-PLM1017	1/4"	1-1/2"	1/4"	\$4.15

Special Long Length Pilot Mandrels & Old Style PM-2



STYLE NO.	ORDER NO.	OVERALL LENGTH	PILOT DIAMETER	PILOT LENGTH	SHANK DIAMETER	PRICE EACH
PM-2 Special	08G-PLM1020	4"	3/32"	1"	1/4"	\$4.70
PM-2 Special*	08G-PLM1024	2-7/8"	3/32"	1"	1/8"	\$2.35
PM-8 Special	08G-PLM1021	4"	1/8"	1"	1/4"	\$5.50
PM-8 Special	08G-PLM1022	6"	1/8"	1"	1/4"	\$8.20
PM-13 Special	08G-PLM1023	6"	3/16"	1"	1/4"	\$8.20

* Old Style with larger diameter screw thread.

QUANTITY DISCOUNTS

- 25 SAME PACKAGE 10%
- 100 SAME PACKAGE 15%
- 200 SAME PACKAGE 20%



Cone Point Mandrels

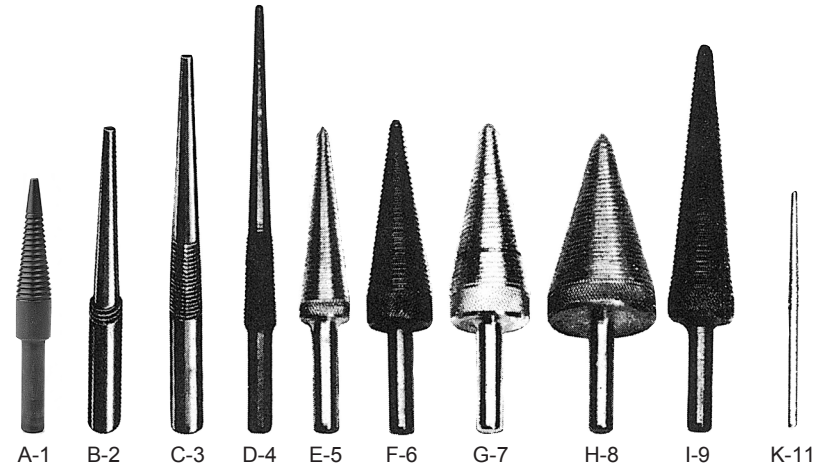

* All shanks are 1/4" except K-11 which is 1/8"

STYLE NO.	ORDER NO.	PRICE/EACH
A-1	08L-CPM1100	\$5.25
B-2	08L-CPM1200	\$5.25
C-3	08L-CPM1300	\$5.25
D-4	08L-CPM1400	\$5.25
E-5	08L-CPM1500	\$6.75
F-6	08L-CPM1600	\$6.75
G-7	08L-CPM1700	\$7.25
H-8	08L-CPM1800	\$7.95
I-9	08L-CPM1900	\$9.25
K-11	08L-CPM2000	\$5.60

Falcon Rubber Cushioned Arbors

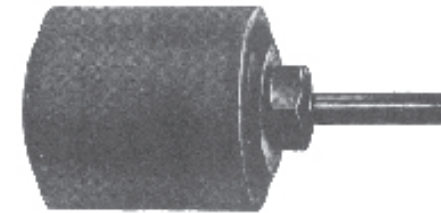

STYLE NO.	ORDER NO.	SIZE (IN)	SHANK	PRICE EACH
RC-1	08J-RCA1000	1/4 x 1/2	1/8"	\$1.90
RC-2	08J-RCA2000	3/8 x 1/2	1/8"	\$2.90
RC-3	08J-RCA3000	1/2 x 1/2	1/8"	\$2.60
RC-3	08J-RCA3500	1/2 x 1/2	1/4"	\$2.60
RC-5	08J-RCA5000	3/4 x 1/2	1/8"	\$2.80
RC-5	08J-RCA5500	3/4 x 1/2	1/4"	\$2.80
RC-7	08J-RCA7000	1 x 1	1/4"	\$3.35

QUANTITY DISCOUNTS 25 OF SAME 10%

Falcon Flap Wheels

Made of Aluminum Oxide Resin Bond Cloth and mounted on a permanent shank. Flap wheels are extremely durable, easy to use and provide fast consistent performance in contour work, blending, finishing, deburring, cleaning and polishing. Flap wheels are typically used on ferrous and non-ferrous metals, rubber, wood and plastic.

NO DIGGING — NO FLATTING

DIAMETER RANGE — 1-3/16" to 3-1/8"

GRIT RANGE — 50 through 400

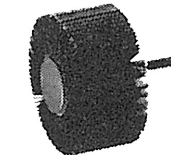

Diameter: 1-3/16" • Width 3/16"
Shank Diameter 1/8" • Max RPM 15,000*
Price Each - \$5.85

GRIT	ORDER NO.	GRIT	ORDER NO.
80	08M-FLW1002	150	08M-FLW1004
120	08M-FLW1003	320	08M-FLW1007

Diameter: 1-3/16" • Width 3/8"
Shank Diameter 1/8" • Max RPM 15,000*
Price Each - \$6.05

GRIT	ORDER NO.	GRIT	ORDER NO.
80	08M-FLW1102	320	08M-FLW1107
120	08M-FLW1103	400	08M-FLW1108
240	08M-FLW1106		

Diameter: 1-1/2" • Width 5/8"
Shank Diameter 1/4" • Max RPM 12,000*
Price Each - \$6.85

GRIT	ORDER NO.	GRIT	ORDER NO.
60	08M-FLW1201	180	08M-FLW1205
120	08M-FLW1203	400	08M-FLW1208

Diameter: 2" • Width 3/8"
Shank Diameter 1/4" • Max RPM 9500*
Price Each - \$6.80

GRIT	ORDER NO.	GRIT	ORDER NO.
80	08M-FLW1302	320	08M-FLW1307
120	08M-FLW1303		

Diameter: 2" • Width 3/4"
Shank Diameter 1/4" • Max RPM 9500*
Price Each - \$8.00

GRIT	ORDER NO.	GRIT	ORDER NO.
60	08M-FLW1401	120	08M-FLW1403
80	08M-FLW1402	400	08M-FLW1408

QUANTITY DISCOUNTS 25 OF SAME 10% 100 OF SAME 15%

QUANTITY DISCOUNTS 12+ PIECES OF THE SAME 20% 150+ PIECES OF THE SAME 30%

*This is the maximum RPM at which these wheels should be run. At high speed the coarse grit gives finer effect; at low speed, the finer grit gives a coarser finish.



Belt Sticks & Replacements Belts

ECONOMICAL & VERSATILE TOOLS

Belt Sticks are ideal tools for metal finishing, woodworking, mold finishing, ceramics, electronics, pattern making, welding cleanup, jewelry making, gun repair, and much more.

PRODUCT FEATURES

- Features three working areas: a flat bottom, a round end and a tapered end for intricate areas
Accommodates 1/4", 1/2" or 3/4" wide aluminum oxide abrasive belts
Spring-loaded tensioning device allows the abrasive belt to be quickly changed and also rotated so that all areas of the belt can be used
Resin-bonded cloth-backed aluminum oxide
Replaceable abrasive belts can be easily indexed around the tool enabling the economical use of the entire abrasive material
Ergonomic shape for added comfort
Thumb and finger supports for added control
Supplied in 5 colors to quickly distinguish one grit from another
Made in the USA

Belt Sticks



Table with 6 columns: SIZE, RED (120 GRIT), BLUE (240 GRIT), GREEN (320 GRIT), YELLOW (400 GRIT), BLACK (600 GRIT). Rows include sizes 1/4 x 6, 1/2 x 8, and 3/4 x 10 with corresponding part numbers and prices.

Replacement Belts - Sold in Packages of 10

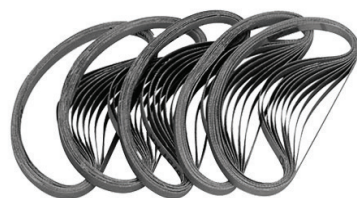

Table with 6 columns: SIZE, RED (120 GRIT), BLUE (240 GRIT), GREEN (320 GRIT), YELLOW (400 GRIT), BLACK (600 GRIT). Rows include sizes 1/4 x 6, 1/2 x 8, and 3/4 x 10 with corresponding part numbers and prices.

Belt Stick Kit

10 piece Belt Stick Kit includes 5 Belt Sticks in a 1/4" size: 1 each of Red (120 Grit), Blue (240 Grit), Green (320 Grit), Yellow (400 Grit), and Black (600 Grit) each equipped with 1 abrasive belt.

ITEM NO. 08Q-SBS9000 \$7.50

Cratex® Tool & Die Maker Kits

For deburring, smoothing, cleaning and polishing

CRATEX® RUBBERIZED ABRASIVES ARE USED FOR:

- Light deburring to remove visible and microscopic burrs
Smoothing to improve wearing qualities and to reduce the danger of fatigue failure
Cleaning to remove undesirable surface deposits
Polishing to improve performance, appearance, cleanliness and to lessen the dangers of surface erosion or contamination

Cratex® Rubberized Abrasives are made with first quality silicon carbide, evenly distributed throughout a premium grade oil-resistant chemical rubber bond. In contrast to hard grinding wheels the Cratex® bond has a unique cushioned action. It resists loading and cuts smoothly without gouging into the work surface. Cratex® Rubberized Abrasives can be used with water or typical shop coolants and will not harden or soften with age or in actual use. If any Cratex® item does not perform as expected, it is returnable for full credit or exchange. Cratex® Rubberized Abrasives are formed in high precision compression molds and each Cratex® size and shape is made in four standard grit textures.



Cratex® Polishing Kit
22 popular wheels, cones & blocks in Grits C, M, F, & XF, plus 2 mandrels.

Cratex® No. 232
08N-CTX9238
\$258.84

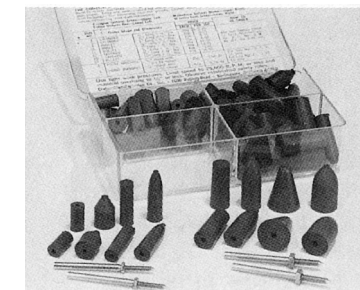

Cratex® Point Test Kit

Kit No. 778
08N-CTX9778
\$100.42



Cratex® Point and Mandrel Kit No. 777 ORDER NO. 08N-CTX9777 \$84.42

Kit No. 777 contains 80 Wheels and Points plus 4 Mandrels. Packaged in a four compartment plastic box by grit textures C, M, F, & XF for easy selection. Ideal for use in a wide range of polishing, smoothing and deburring applications.

CONTENTS OF KIT 777
8 Tapered Edge Wheels No. 2 - 5/8" dia.
16 Straight Wheels No. 74 - 7/8" dia. x 1/8" thick
8 Straight Wheels No. 86 - 1" dia. x 3/16" thick
16 Cylinder Points No. 6 - 7/8" length x 1/4" dia.
16 Bullet Points No. 8 - 1" length x 9/32" dia.
8 Bullet Points No. 10 - 5/8" length x 3/8" dia.
2 Wheel Mandrels No. 3 - 1/8" shank
2 Point Mandrels No. 4 - 1/8" shank

All assortments equally divided in the four Cratex® Grit Textures: Coarse, Medium, Fine and Extra Fine.



Shaped Wheels and Points

1/16" Center Hole

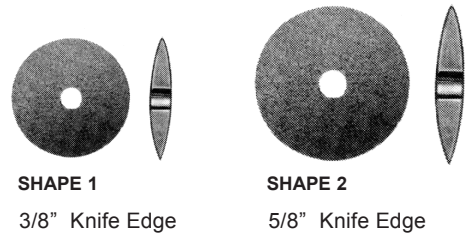

SHAPE 1 3/8" Knife Edge, SHAPE 2 5/8" Knife Edge

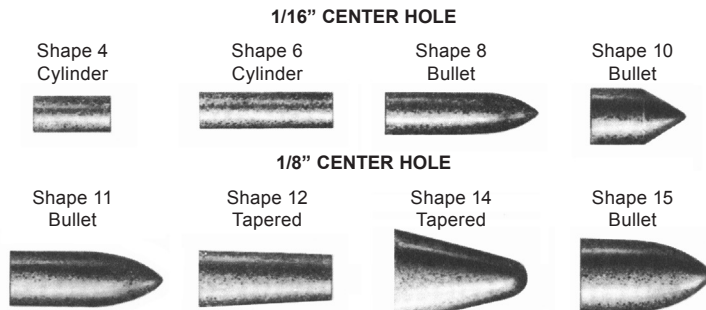

Shape 4 Cylinder, Shape 6 Cylinder, Shape 8 Bullet, Shape 10 Bullet, Shape 11 Bullet, Shape 12 Tapered, Shape 14 Tapered, Shape 15 Bullet

Table with columns: DIMENSIONS & SHAPE IN INCHES, C (COARSE), M (MEDIUM), F (FINE), XF (EXTRA FINE), PRICE PER 100. Rows include Wheels - Knife Edge, Points - Cylinder, Points - Bullet, and Points - Tapered.

Straight Wheels

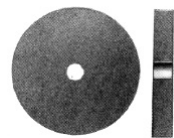

For Mandrels, See Page 226.

Cratex® Grit Specification table with columns: TEXTURE, CODE, COLOR, GRIT and rows: Coarse, Medium, Fine, Extra Fine.

Table with columns: DIMENSIONS (INCHES), C (COARSE), M (MEDIUM), F (FINE), XF (EXTRA FINE), PRICE PER 100. Rows include dimensions from 3/8" to 1" diameter.

Straight Wheels, Large

Large table with columns: DIMENSIONS (INCHES), C (COARSE), M (MEDIUM), F (FINE), XF (EXTRA FINE), PRICE PER 100. Rows include dimensions from 1 1/2" to 8" diameter.

For Mandrels, see page 106.



Round, Square, Rectangular Blocks & Sticks

Square

DIMENSIONS (INCHES)		C (COARSE)		M (MEDIUM)		F (FINE)		XF (EXTRA FINE)		PRICE PER 100
DIA.	HOLE	CRATEX® NO.	ORDER NO.	CRATEX® NO.	ORDER NO.	CRATEX® NO.	ORDER NO.	CRATEX® NO.	ORDER NO.	
6	1/4 x 1/4	6202-C	08N-CTX8301	6202-M	08N-CTX8302	6202-F	08N-CTX8303	6202-XF	08N-CTX8304	\$7.21
	1/2 x 1/2	6404-C	08N-CTX8311	6404-M	08N-CTX8312	6404-F	08N-CTX8313	6404-XF	08N-CTX8314	\$12.40
	3/4 x 3/4	6606-C	08N-CTX8321	6606-M	08N-CTX8322	6606-F	08N-CTX8323	6606-XF	08N-CTX8324	\$21.79
	1 x 1	6808-C	08N-CTX8331	6808-M	08N-CTX8332	6808-F	08N-CTX8333	6808-XF	08N-CTX8334	\$29.52

Rectangular

DIMENSIONS (INCHES)		C (COARSE)		M (MEDIUM)		F (FINE)		XF (EXTRA FINE)		PRICE PER 100
DIA.	HOLE	CRATEX® NO.	ORDER NO.	CRATEX® NO.	ORDER NO.	CRATEX® NO.	ORDER NO.	CRATEX® NO.	ORDER NO.	
3	1 x 1/4	3802-C	08N-CTX8401	3802-M	08N-CTX8402	3802-F	08N-CTX8403	3802-XF	08N-CTX8404	\$7.21
	2 x 3/8	4163-C	08N-CTX8411	4163-M	08N-CTX8412	4163-F	08N-CTX8413	4163-XF	08N-CTX8414	\$16.20
4	1 x 1/8	6801-C	08N-CTX8421	6801-M	08N-CTX8422	6801-F	08N-CTX8423	6801-XF	08N-CTX8424	\$10.43
	1 x 1/4	6802-C	08N-CTX8431	6802-M	08N-CTX8432	6802-F	08N-CTX8433	6802-XF	08N-CTX8434	\$12.40
	1 x 3/8	6803-C	08N-CTX8441	6803-M	08N-CTX8442	6803-F	08N-CTX8443	6803-XF	08N-CTX8444	\$14.23
6	2 x 1/4	6162-C	08N-CTX8451	6162-M	08N-CTX8452	6162-F	08N-CTX8453	6162-XF	08N-CTX8454	\$23.95
	2 x 1	6168-C	08N-CTX8461	6168-M	08N-CTX8462	6168-F	08N-CTX8463	6168-XF	08N-CTX8464	\$54.92
8	1 x 1/2	8804-C	08N-CTX8471	8804-M	08N-CTX8472	8804-F	08N-CTX8473	8804-XF	08N-CTX8474	\$36.70

Round

DIMENSIONS (INCHES)		C (COARSE)		M (MEDIUM)		F (FINE)		XF (EXTRA FINE)		PRICE PER 100
DIA.	HOLE	CRATEX® NO.	ORDER NO.	CRATEX® NO.	ORDER NO.	CRATEX® NO.	ORDER NO.	CRATEX® NO.	ORDER NO.	
6	3/16	036-C	08N-CTX8201	036-M	08N-CTX8202	036-F	08N-CTX8203	036-XF	08N-CTX8204	\$5.76
	1/4	046-C	08N-CTX8211	046-M	08N-CTX8212	046-F	08N-CTX8213	046-XF	08N-CTX8214	\$6.47
	5/16	056-C	08N-CTX8221	056-M	08N-CTX8222	056-F	08N-CTX8223	056-XF	08N-CTX8224	\$7.21
6	3/8	066-C	08N-CTX8231	066-M	08N-CTX8232	066-F	08N-CTX8233	066-XF	08N-CTX8234	\$7.37
	1/2	086-C	08N-CTX8241	086-M	08N-CTX8242	086-F	08N-CTX8243	086-XF	08N-CTX8244	\$10.28
	5/8	0106-C	08N-CTX8251	0106-M	08N-CTX8252	0106-F	08N-CTX8253	0106-XF	08N-CTX8254	\$15.65
	3/4	0126-C	08N-CTX8261	0126-M	08N-CTX8262	0126-F	08N-CTX8263	0126-XF	08N-CTX8264	\$19.43
	7/8	0146-C	08N-CTX8271	0146-M	08N-CTX8272	0146-F	08N-CTX8273	0146-XF	08N-CTX8274	\$27.92
6	1	0166-C	08N-CTX8281	0166-M	08N-CTX8282	0166-F	08N-CTX8283	0166-XF	08N-CTX8284	\$34.55

Falcon Polishing Rubber Points

STYLE NO.	ORDER NO.	SIZE	GRIT	COLOR	PRICE
13F	08Z-MS1131	1/4 x 7/8	Fine	Grey	\$63.00 per 100
13C	08Z-MS1132	1/4 x 7/8	Coarse	Red	\$63.00 per 100



For Mandrels, see page 106.

Cratex® Cones

Tapered • Cylinder • Pointed • Bullet Shape

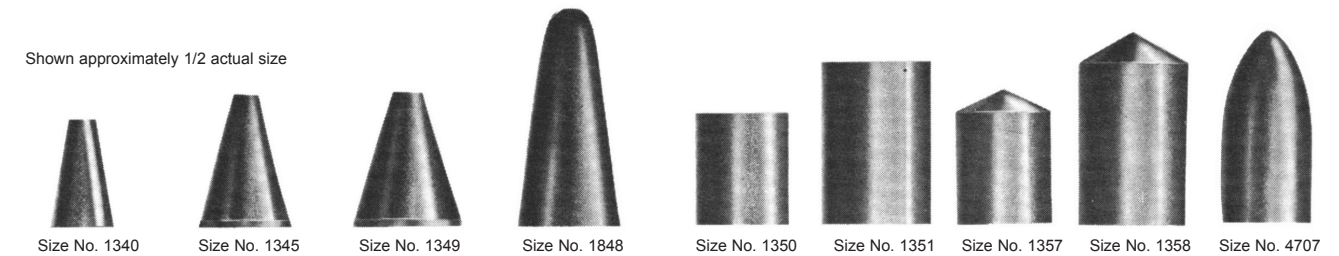

DIMENSIONS (INCHES)			C (COARSE)		M (MEDIUM)		F (FINE)		XF (EXTRA FINE)		PRICE PER 100
SHAPE	LENGTH	DIA.	CRATEX NO.	ORDER NO.	CRATEX NO.	ORDER NO.	CRATEX NO.	ORDER NO.	CRATEX NO.	ORDER NO.	
Tapered	1	5/8 to 1/4	1340-C	08N-CTX8501	1340-M	08N-CTX8502	1340-F	08N-CTX8503	1340-XF	08N-CTX8504	\$5.93
Tapered	1-1/4	7/8 to 1/4	1345-C	08N-CTX8511	1345-M	08N-CTX8512	1345-F	08N-CTX8513	1345-XF	08N-CTX8514	\$10.63
Tapered	1-1/4	1 to 1/4	1349-C	08N-CTX8521	1349-M	08N-CTX8522	1349-F	08N-CTX8523	1349-XF	08N-CTX8524	\$12.79
Tapered	2	1 to 1/2	1848-C	08N-CTX8571	1848-M	08N-CTX8572	1848-F	08N-CTX8573	1848-XF	08N-CTX8574	\$16.94
Cylinder	1	7/8	1350-C	08N-CTX8531	1350-M	08N-CTX8532	1350-F	08N-CTX8533	1350-XF	08N-CTX8534	\$11.17
Cylinder	1-1/2	1	1351-C	08N-CTX8541	1351-M	08N-CTX8542	1351-F	08N-CTX8543	1351-XF	08N-CTX8544	\$14.23
Pointed	1-1/4	7/8	1357-C	08N-CTX8551	1357-M	08N-CTX8552	1357-F	08N-CTX8553	1357-XF	08N-CTX8554	\$11.15
Pointed	1-3/4	1	1358-C	08N-CTX8561	1358-M	08N-CTX8562	1358-F	08N-CTX8563	1358-XF	08N-CTX8564	\$16.20
Bullet	1-3/4	7/8	4707-C	08N-CTX8581	4707-M	08N-CTX8582	4707-F	08N-CTX8583	4707-XF	08N-CTX8584	\$16.20

Maximum Safe Speed 20,000 Revolutions Per Minute. Best results are usually obtained at 30% to 80% of Maximum Safe Speed. Use a light work pressure. Use Mandrel No. 142. See page 106.

Press-On Discs Aluminum Oxide Glue Bond

FEATURES & BENEFITS

- Premium aluminum oxide grain
- Highest quality pressure sensitive adhesive
- Heat resistant adhesive, eliminates disc flying off during operation

APPLICATIONS

- Ideal for for light blending and contoured areas
- Non-ferrous and ferrous metals

Packed 50 discs per package, priced per 100 discs.

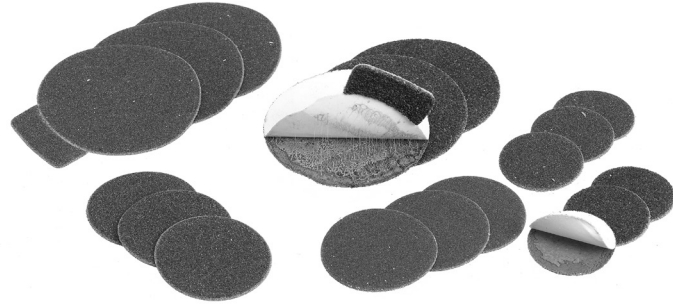

Style PD10 • Diameter: 1/2" • Price per 100

GRIT	ORDER NO.	80 GRIT & COARSER	100 GRIT & FINER
50	08P-POD1001	\$20.00	—
60	08P-POD1002	\$20.00	—
80	08P-POD1003	\$20.00	—
100	08P-POD1004	—	\$16.00
120	08P-POD1005	—	\$16.00
150	08P-POD1006	—	\$16.00
180	08P-POD1007	—	\$16.00
240	08P-POD1008	—	\$16.00
320	08P-POD1009	—	\$16.00
500	08P-POD1011	—	\$16.00

Style PD11 • Diameter: 3/4" • Price per 100

GRIT	ORDER NO.	80 GRIT & COARSER	100 GRIT & FINER
60	08P-POD1102	\$21.00	—
80	08P-POD1103	\$21.00	—
100	08P-POD1104	—	\$17.00
120	08P-POD1105	—	\$17.00
180	08P-POD1107	—	\$17.00
240	08P-POD1108	—	\$17.00
320	08P-POD1109	—	\$17.00
400	08P-POD1110	—	\$17.00
500	08P-POD1111	—	\$17.00

Style PD12 • Diameter: 1" • Price per 100

GRIT	ORDER NO.	80 GRIT & COARSER	100 GRIT & FINER
60	08P-POD1202	\$22.00	—
80	08P-POD1203	\$22.00	—
100	08P-POD1204	—	\$19.00
120	08P-POD1205	—	\$19.00
150	08P-POD1206	—	\$19.00
180	08P-POD1207	—	\$19.00
240	08P-POD1208	—	\$19.00
320	08P-POD1209	—	\$19.00
400	08P-POD1210	—	\$19.00
500	08P-POD1211	—	\$19.00

Style PD13 • Diameter: 1-1/2" • Price per 100

GRIT	ORDER NO.	80 GRIT & COARSER	100 GRIT & FINER
50	08P-POD1301	\$24.00	—
80	08P-POD1303	\$24.00	—
100	08P-POD1304	—	\$22.00
120	08P-POD1305	—	\$22.00
180	08P-POD1307	—	\$22.00
320	08P-POD1309	—	\$22.00

Style PD14 • Diameter: 2" • Price per 100

GRIT	ORDER NO.	80 GRIT & COARSER	100 GRIT & FINER
120	08P-POD1405	—	\$39.00
180	08P-POD1407	—	\$39.00
240	08P-POD1408	—	\$39.00
320	08P-POD1409	—	\$39.00

Falcon Press-on Disc Holders

STYLE NO.	DIAMETER (INCHES)	ORDER NO. 1/8" SHANK SIZE	ORDER NO. 1/4" SHANK SIZE	PRICE EACH
RD10	1/2	08P-POD5010	08P-POD6010	\$2.75
RD11	3/4	08P-POD5011	08P-POD6011	\$3.53
RD12	1	08P-POD5012	08P-POD6012	\$3.94
RD13	1-1/2	08P-POD5013	08P-POD6013	\$4.55
RD14	2	—	08P-POD6014	\$5.55

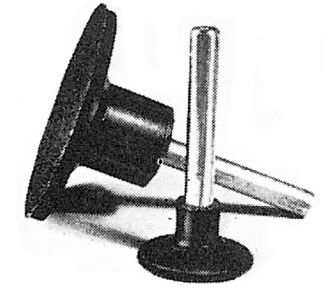

Falcon Abrasive Press-on Strips

Press-on Strip Holders

08Q-POS5000 \$7.10 each

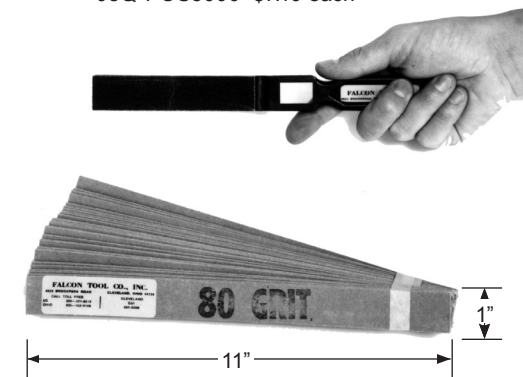

GRIT	ORDER NO.	PRICE PER PACKAGE (50 STRIPS/PKG)
60	08Q-POS1000	\$36.00
80	08Q-POS1001	\$36.00
100	08Q-POS1002	\$36.00
120	08Q-POS1003	\$36.00
150	08Q-POS1004	\$36.00
180	08Q-POS1005	\$36.00
240	08Q-POS1006	\$36.00
320	08Q-POS1007	\$36.00
400	08Q-POS1008	\$36.00



APPROXIMATE THICKNESS:

16 ply = 5/32"	42 ply = 7/16"	55 ply = 9/16"
30 ply = 5/16"	45 ply = 7/16"	60 ply = 5/8"
35 ply = 3/8"	50 ply = 1/2"	70 ply = 3/4"

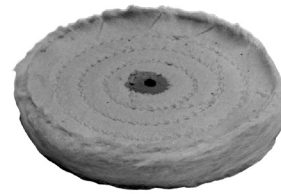

Fine Muslin Buffs

STYLE NO.	ORDER NO.	DIAMETER (INCHES)	PLY	SEWING	PRICE EACH
MBF-1	08R-MBF1001	7/8	16	1	\$0.85
MBF-2	08R-MBF1002	1	16	1	\$0.85
MBF-3	08R-MBF1003	1-1/4	16	3	\$0.95
MBF-4	08R-MBF1004	1-1/2	16	3	\$1.05
MBF-5	08R-MBF1005	2	16	4	\$1.15
MBF-6	08R-MBF1006	4	50	4	\$3.45
MBF-8	08R-MBF1008	6	60	6	\$7.55
MBF-10	08R-MBF1010	8	70	7	\$14.85

Regular Muslin Buffs

STYLE NO.	ORDER NO.	DIAMETER (INCHES)	PLY	SEWING	PRICE EACH
MBR-1	08R-MBF2001	2	30	2	\$1.60
MBR-2	08R-MBF2002	2-1/2	30	2	\$1.70
MBR-3	08R-MBF2003	3	35	3	\$2.00
MBR-4	08R-MBF2004	4	42	3	\$2.60
MBR-5	08R-MBF2005	5	45	3	\$3.70
MBR-6	08R-MBF2006	6	50	4	\$5.00
MBR-8	08R-MBF2008	8	55	4	\$10.05

Muslin Cylinder Buffs



STYLE NO.	ORDER NO.	SIZE (INCHES)	PRICE EACH
MCB-1	08R-MBF3001	2 x 2	\$13.30

Muslin Taper Buffs



STYLE NO.	ORDER NO.	DIAMETER (INCHES)	PRICE EACH
MT-1	08R-MBF4001	2	\$12.20

Muslin Goblet Buffs

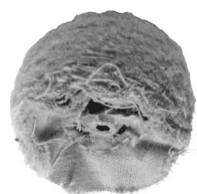

STYLE NO.	ORDER NO.	DIAMETER (INCHES)	PRICE EACH
MG-1	08R-MBF5001	2	\$9.70
MG-2	08R-MBF5002	2-1/2	\$10.95
MG-3	08R-MBF5003	3	\$10.95
MG-5	08R-MBF5005	4	\$16.70

Falcon 12" x 12" Felt Sheets

White Spanish Grade

THICK (INCHES)	SOFT		MEDIUM		HARD	
	ORDER NO.	PRICE/DOZ.	ORDER NO.	PRICE/DOZ.	ORDER NO.	PRICE/DOZ.
1/4	08U-FLT1000	\$24.65	08U-FLT1001	\$27.65	08U-FLT1002	\$34.60
1/2	08U-FLT1006	\$50.60	08U-FLT1007	\$56.45	08U-FLT1008	\$70.75
3/4	08U-FLT1009	\$56.65	08U-FLT1010	\$66.65	08U-FLT1011	\$81.25
1	08U-FLT1012	\$74.35	08U-FLT1013	\$87.75	08U-FLT1014	\$106.80

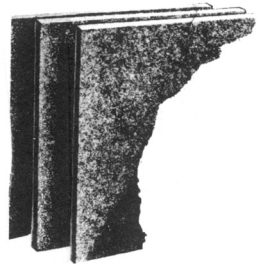

Falcon Knife Edge Felt Wheels

STYLE NO.	ORDER NO.	DIAMETER (INCHES)	PRICE PER DOZEN
KE-2	08U-FLT3002	5/8	\$9.24
KE-3	08U-FLT3003	3/4	\$9.72
KE-4	08U-FLT3004	1	\$11.88
KE-5	08U-FLT3005	1-1/2	\$18.60
KE-6	08U-FLT3006	2	\$28.80
KE-7	08U-FLT3007	2-1/2	\$64.95
KE-8	08U-FLT3008	3	\$79.40

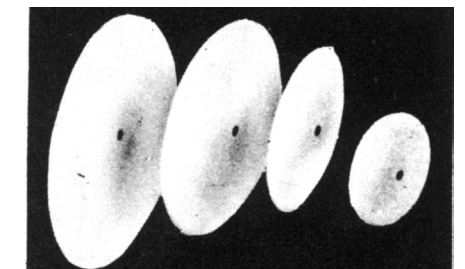

QUANTITY DISCOUNTS
12 DOZEN OF SAME SIZE 10%



Falcon Felt Sticks

6" Long

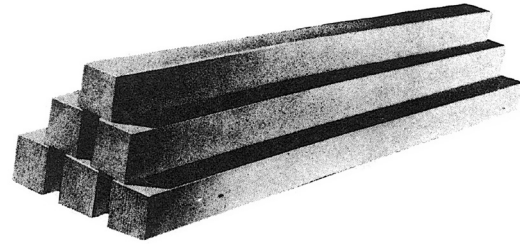

STYLE NO.	SIZE (INCHES)	MEDIUM		HARD	
		ORDER NO.	PRICE EACH	ORDER NO.	PRICE EACH
FS-1	1/4 square	08U-FLT4012	\$1.00	08U-FLT4013	\$1.05
FS-2	3/8 square	08U-FLT4022	\$1.20	08U-FLT4023	\$1.40
FS-3	1/2 square	08U-FLT4032	\$1.45	08U-FLT4033	\$1.65

QUANTITY DISCOUNTS 100 PIECES OF SAME SIZE & HARDNESS 10%

Falcon Mounted Square Felts

1/8" Shank

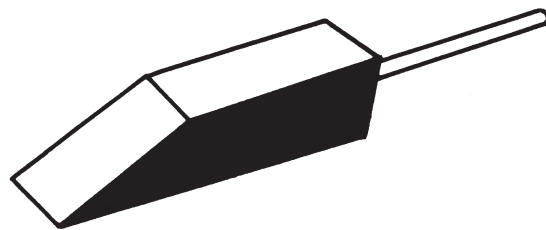

STYLE NO.	SIZE (INCHES)	MEDIUM		HARD	
		ORDER NO.	PRICE EACH	ORDER NO.	PRICE EACH
SF-1	1/4 x 1/4 x 1-1/2	08U-FLT5012	\$1.60	08U-FLT5013	\$1.75
SF-2	3/8 x 3/8 x 1-3/4	08U-FLT5022	\$1.65	08U-FLT5023	\$1.95
SF-3	1/2 x 1/2 x 1-3/4	08U-FLT5032	\$1.75	08U-FLT5033	\$2.00

QUANTITY DISCOUNTS 50 PIECES OF SAME SIZE & HARDNESS 10%

Mounted Felt Bobs • Cylinders

1/8" & 1/4" Shank

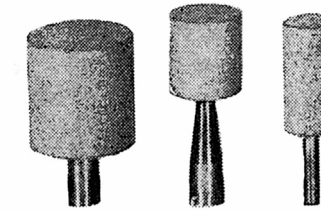

STYLE NO.	DIAMETER (INCHES)	LENGTH (INCHES)	SHANK (INCHES)	SOFT		MEDIUM		HARD		ROCK HARD	
				ORDER NO.	PRICE EACH	ORDER NO.	PRICE EACH	ORDER NO.	PRICE EACH	ORDER NO.	PRICE EACH
MF-1	1/4	1/4	1/8	08V-MFB1011	\$0.75	08V-MFB1012	\$0.85	08V-MFB1013	\$0.95	08V-MFB1014	\$1.05
MF-2	1/4	3/8	1/8	08V-MFB1021	\$0.75	08V-MFB1022	\$0.85	08V-MFB1023	\$0.95	08V-MFB1024	\$1.05
MF-3	3/8	3/8	1/8	08V-MFB1031	\$0.85	08V-MFB1032	\$0.85	08V-MFB1033	\$0.95	08V-MFB1034	\$1.05
MF-4	3/8	1/2	1/8	08V-MFB1041	\$0.80	08V-MFB1042	\$0.90	08V-MFB1043	\$1.00	08V-MFB1044	\$1.15
MF-5	1/2	1/2	1/8	08V-MFB1051	\$0.90	08V-MFB1052	\$1.00	08V-MFB1053	\$1.10	08V-MFB1054	\$1.30
MF-6	1/2	3/4	1/8	08V-MFB1061	\$0.95	08V-MFB1062	\$1.05	08V-MFB1063	\$1.15	—	—
MF-7	1/2	1	1/8	08V-MFB1071	\$1.10	08V-MFB1072	\$1.20	08V-MFB1073	\$1.40	08V-MFB1074	\$1.60
MF-8	3/4	3/4	1/8	08V-MFB1081	\$1.30	08V-MFB1082	\$1.45	08V-MFB1083	\$1.60	08V-MFB1084	\$1.90
MF-9	3/4	1	1/8	08V-MFB1091	\$1.40	08V-MFB1092	\$1.55	08V-MFB1093	\$1.70	08V-MFB1094	\$2.05
MF-10	3/4	1-1/2	1/4	08V-MFB1101	\$2.20	08V-MFB1102	\$2.40	08V-MFB1103	\$2.70	08V-MFB1104	\$3.15
MF-11	1	1	1/8	08V-MFB1111	\$1.85	08V-MFB1112	\$2.05	08V-MFB1113	\$2.20	08V-MFB1114	\$2.50
MF-11	1	1	1/4	08V-MFB1115	\$1.85	08V-MFB1116	\$2.05	08V-MFB1117	\$2.20	08V-MFB1118	\$2.50
MF-12	1	1-1/4	1/4	08V-MFB1121	\$2.25	08V-MFB1122	\$2.50	08V-MFB1123	\$2.70	—	—
MF-13	1	1-1/2	1/4	08V-MFB1131	\$2.30	08V-MFB1132	\$2.55	08V-MFB1133	\$2.75	—	—
MF-14	1	2	1/4	08V-MFB1141	\$2.40	08V-MFB1142	\$2.65	08V-MFB1143	\$2.90	—	—
MF-15	1-1/4	1	1/4	08V-MFB1151	\$2.25	08V-MFB1152	\$2.50	08V-MFB1153	\$2.70	08V-MFB1154	\$3.15
MF-16	1-1/4	1-1/4	1/4	08V-MFB1161	\$2.95	08V-MFB1162	\$3.25	08V-MFB1163	\$3.60	08V-MFB1164	\$4.25
MF-17	1-1/2	1	1/4	08V-MFB1171	\$2.50	08V-MFB1172	\$2.75	08V-MFB1173	\$3.00	08V-MFB1174	\$3.55
MF-18	1-1/2	1-1/2	1/4	08V-MFB1181	\$3.65	08V-MFB1182	\$4.00	08V-MFB1183	\$4.45	08V-MFB1184	\$5.25

QUANTITY DISCOUNTS 100 OF A KIND 10% 500 OF A KIND 15%



Mounted Felt Bobs • Shapes

1/8" & 1/4" Shank

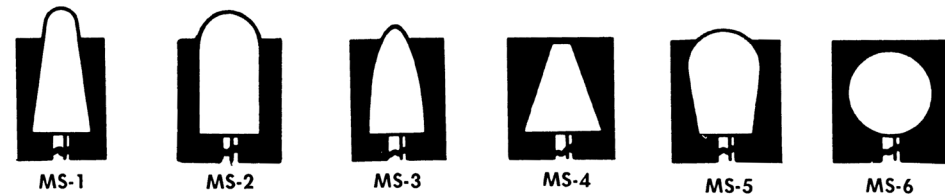

STYLE NO.	DIAMETER (INCHES)	LENGTH (INCHES)	SHANK (INCHES)	SOFT		MEDIUM		HARD		ROCK HARD	
				ORDER NO.	PRICE EACH	ORDER NO.	PRICE EACH	ORDER NO.	PRICE EACH	ORDER NO.	PRICE EACH
MS-1A	1/2	1	1/8	08V-MFB2000	\$1.30	08V-MFB2001	\$1.45	08V-MFB2002	\$1.60	—	—
MS-1B	3/4	1-1/2	1/4	08V-MFB2004	\$1.90	08V-MFB2005	\$2.10	08V-MFB2006	\$2.30	08V-MFB2007	\$2.70
MS-1C	1	2	1/4	08V-MFB2008	\$2.45	08V-MFB2009	\$2.70	08V-MFB2010	\$2.95	08V-MFB2011	\$3.50
MS-2A	1/4	1/2	1/8	08V-MFB2012	\$1.25	08V-MFB2013	\$1.40	08V-MFB2014	\$1.55	08V-MFB2015	\$1.75
MS-2C	3/4	1-1/2	1/4	08V-MFB2016	\$1.90	08V-MFB2017	\$2.10	08V-MFB2018	\$2.30	08V-MFB2019	\$2.70
MS-2D	3/8	3/4	1/8	08V-MFB2020	\$1.25	08V-MFB2021	\$1.40	08V-MFB2022	\$1.55	08V-MFB2023	\$1.75
MS-2E	1/2	1	1/8	08V-MFB2024	\$1.25	08V-MFB2025	\$1.40	08V-MFB2026	\$1.55	08V-MFB2027	\$1.75
MS-2F	1	2	1/4	08V-MFB2028	\$2.45	08V-MFB2029	\$2.70	08V-MFB2030	\$2.95	08V-MFB2031	\$3.50
MS-3A	1/2	1	1/8	08V-MFB2032	\$1.30	08V-MFB2033	\$1.45	08V-MFB2034	\$1.60	08V-MFB2035	\$1.90
MS-3B	3/4	1-1/2	1/4	08V-MFB2036	\$2.65	08V-MFB2037	\$2.90	08V-MFB2038	\$3.25	08V-MFB2039	\$3.80
MS-3C	1	2	1/4	08V-MFB2040	\$2.45	08V-MFB2041	\$2.70	08V-MFB2042	\$2.95	08V-MFB2043	\$3.50
MS-3D	1/4	1/2	1/8	08V-MFB2044	\$1.25	08V-MFB2045	\$1.40	08V-MFB2046	\$1.55	08V-MFB2047	\$1.75
MS-3E	3/8	3/4	1/8	08V-MFB2048	\$1.25	08V-MFB2049	\$1.40	08V-MFB2050	\$1.55	08V-MFB2051	\$1.75
MS-4A	1/2	3/4	1/8	08V-MFB2052	\$1.25	08V-MFB2053	\$1.40	08V-MFB2054	\$1.55	08V-MFB2055	\$1.75
MS-4B	3/4	1	1/4	08V-MFB2056	\$2.10	08V-MFB2057	\$2.30	08V-MFB2058	\$2.60	08V-MFB2059	\$3.00
MS-4C	1	1-1/4	1/4	08V-MFB2060	\$2.65	08V-MFB2061	\$2.90	08V-MFB2062	\$3.25	08V-MFB2063	\$3.80
MS-5A	1/2	3/4	1/8	08V-MFB2064	\$1.25	08V-MFB2065	\$1.40	08V-MFB2066	\$1.55	08V-MFB2067	\$1.75
MS-5B	3/4	1	1/4	08V-MFB2068	\$2.10	08V-MFB2069	\$2.30	08V-MFB2070	\$2.60	08V-MFB2071	\$3.00
MS-5C	1	1-1/4	1/4	08V-MFB2072	\$2.65	08V-MFB2073	\$2.90	08V-MFB2074	\$3.25	08V-MFB2075	\$3.80
MS-6A	1/2	1/2	1/8	08V-MFB2076	\$1.10	08V-MFB2077	\$1.20	08V-MFB2078	\$1.40	08V-MFB2079	\$1.60
MS-6B	3/4	3/4	1/4	08V-MFB2080	\$1.90	08V-MFB2081	\$2.10	08V-MFB2082	\$2.30	08V-MFB2083	\$2.70
MS-6C	1	1	1/4	08V-MFB2084	\$2.35	08V-MFB2085	\$2.60	08V-MFB2086	\$2.85	08V-MFB2087	\$3.36

QUANTITY DISCOUNTS

100 OF A KIND 10%

500 OF A KIND 15%

T-1 Felt Touch-Up Pad

1" x 3" x 1/8" Thick

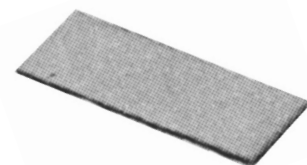

HARDNESS	ORDER NO.	PRICE EACH
Medium	08U-FLT4100	\$1.25
Hard	08U-FLT4101	\$1.45

Bob Assortment Kits

An assortment of Felt Bobs, available at a price considerably below that of individual bobs if purchased separately.



K-1 Bob Kit

ORDER NO. 08V-MFB9001
\$59.40

K-2 Bob Kit

(K-1 Kit plus 4 compound sticks)
ORDER NO. 08V-MFB9002
\$63.60

144 Piece Brush Assortment for Mold & Die Polishing

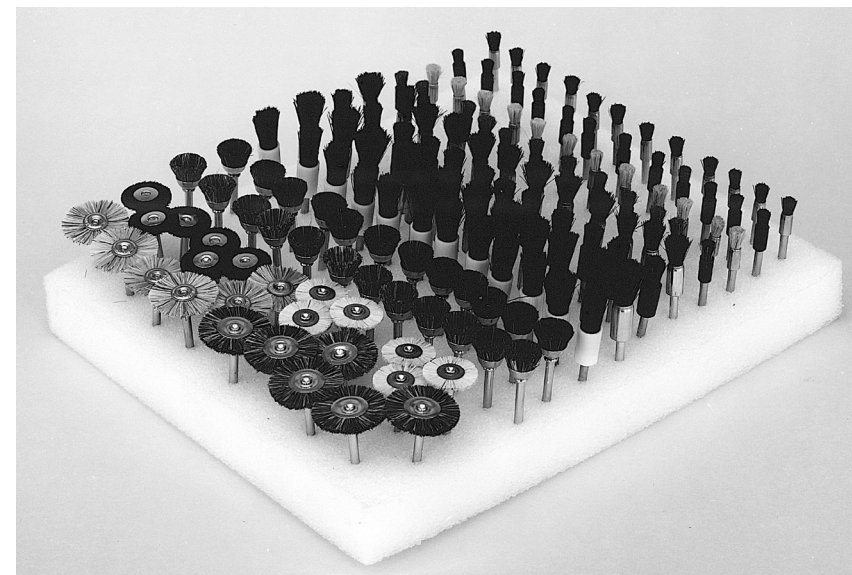

Assortment includes one dozen each of: Style No. SH-2, SH-7, SH-8, SAP-2, SAP-7, SAP-8, SG-2, SGP-2, HC-2, GC-2
Assortment includes six pieces of: Style No. HC-3, HC-5, GC-5, GC-6

Same set of 144 pcs.

ORDER NO. 08W-BRU9000
\$166.00

Note: See Pages 224-225 for specifications on brushes included.



End Brushes

QUANTITY DISCOUNTS

12+ OF SAME 15%
144+ OF SAME 30%

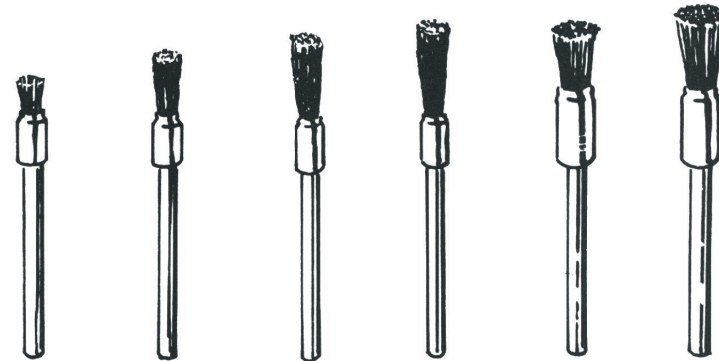

Table with columns for SHANK, BRISTLE DIAMETER, BRISTLE LENGTH, and various brush styles including Stiff Horsehair, Plastic Ferrule, Soft Goat Hair, Brass Wire, and Steel Wire.

Cup & Wheel Brushes

Max Safe Speed For All Miniature Brushes is 25,000 RPM

QUANTITY DISCOUNTS

12+ OF SAME 15%
144+ OF SAME 30%



Table with columns for SHANK, BRISTLE DIAMETER, and various brush styles including Stiff Horsehair, Soft Goat Hair, Brass Wire, and Steel Wire.

Wheel Mandrels

STYLE NO.	105	106	107	108	109	110	111
ORDER NO.	08S-MDR0105	08S-MDR0106	08S-MDR0107	08S-MDR0108	08S-MDR0109	08S-MDR0110	08S-MDR0111
SCREW	1/16	1/16	1/16	1/16	1/16	1/16	1/8
SHANK	3/32	3/32	3/32	1/8	1/8	1/8	1/8
PRICE	\$0.40	\$0.40	\$0.40	\$0.45	\$0.45	\$0.45	\$0.50

STYLE NO.	112	113	114	115	116	118
ORDER NO.	08S-MDR0112	08S-MDR0113	08S-MDR0114	08S-MDR0115	08S-MDR0116	08S-MDR0118
SCREW	1/8	1/8	1/4	1/8	1/4	1/16
SHANK	1/8	1/8	1/8	1/4	1/4	1/4
PRICE	\$0.60	\$0.90	\$1.15	\$1.25	\$1.15	\$1.40

Heavy Duty Wheel Mandrels

STYLE NO.	120	121	122	123
ORDER NO.	08S-MDR0120	08S-MDR0121	08S-MDR0122	08S-MDR0123
SCREW SIZE	1/4	1/4	1/4	1/4
THREAD LENGTH	1/2	3/4	1	1-1/4
SHANK	1/4	1/4	1/4	1/4
PRICE	\$2.20	\$2.20	\$2.20	\$2.20



Felt Wheel & Bob Mandrels

STYLE NO.	130	131	132	133	134	135	136	137
ORDER NO.	08S-MDR0130	08S-MDR0131	08S-MDR0132	08S-MDR0133	08S-MDR0134	08S-MDR0135	08S-MDR0136	08S-MDR0137
SHANK	3/32	1/8	1/8	1/8	1/8	1/4	1/4	1/4
ORDER NO.	—	—	—	—	—	08S-MDR1135	08S-MDR1136	08S-MDR1137
SHANK	—	—	—	—	—	1/8	1/8	1/8
PRICE	\$0.45	\$0.45	\$0.45	\$0.45	\$0.45	\$4.55	\$4.45	\$5.05

Rubber Point Mandrels

STYLE NO.	140	141	141-A	141-B	142
ORDER NO.	08S-MDR0140	08S-MDR0141	08S-MDR1141	08S-MDR2141	08S-MDR0142
SCREW	1/16	1/16	1/8	1/8	1/4
SHANK	3/32	1/8	1/8	1/4	1/4
PRICE	\$2.80	\$3.80	\$4.44	\$6.72	\$6.54

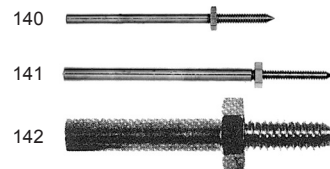

Air & Ultrasonic Profilers

The perfect tools for polishing fine detail areas.

Turbo-Lap and U-LAP units offer excellent performance with:

- Ceramic Super Stones
- Ceramic Diamond Stones
- Cristones®
- Variety of Falcon Mold Polishing Stones

**All Air Profilers
\$399.00**

Turbo-Lap Units

Must be used at a maximum of 85 PSI. Use with filtered dry air. No Lubrication.

ORDER NO.	MODEL	STROKE	RPM	MOVEMENT
09T-LAP0003	TLL-03	0.3 mm	52,000	Linear
09T-LAP0007	TLL-07	0.7 - 0.027 mm	28,000	Linear
09T-LAP0012	TLS-12	1.5 mm	14,000	Swing - 3 mm left to right and 1.2 mm Linear. 12,000 strokes per minute



U-Lap Units

Must be used at a maximum of 85 PSI. Requires an air filter/lubricator similar to Falcon Item # 09L-DOP1258

ORDER NO.	MODEL	STROKE	RPM
09U-LAP0030	U-LAP 30	0.3 mm	30,000
09U-LAP0070	U-LAP 70	0.7 mm	28,000
09U-LAP0120	U-LAP 120	1.2 mm	25,000
09U-LAP0300	U-LAP 300	3.0 mm	10,000



Ultrasonic Eco Polisher - Electric



High performance ultrasonic polishing machine ideal for precision polishing and deburring. Specially designed for efficient use of detail stones including Ceramic Super Stones and Cristones®. Stable body design and smooth vibration to prevent fatigue even after long time use.

Includes: Hand Piece, Vertical and Flare Shape Controller, Speed Control Foot Pedal, Hand Piece Holder, and 3 ceramic stone holders to accommodate flat stones 0.5-1.5mm and 2.34mm and 3.0mm round stones.

Ultrasonic Eco Polisher
09V-EPC1000
\$1,100.00



Stone Holders & Air Profilers	ORDER NO.	DESCRIPTION	PRICE
	02N-HDR5005	Holder for Profiler, 3/16" Shank, for 1/8x1/4 stones	\$5.85
	02N-HDR5006	Holder for Profiler, 3/16" Shank, for 1/8x1/2, 1/4x1/4 stones	\$5.85
	02N-HDR5007	Holder for Profiler, 1/8" Shank, for 1/8x1/4 stones	\$5.85
	02N-HDR5008	Holder for Profiler, 1/8" Shank, for 1/8x1/2, 1/4x1/4 stones	\$5.85
	02N-HDR5009	Vice Clamp Holder for Profiler, 3/16" Shank	\$28.05
	02N-HDR5010	Vice Clamp Holder for Profiler, 1/8" Shank	\$28.05
	02N-HDR5020	Ceramic Stone Holder for Profilers, 1/8" Shank	\$29.27
	02N-HDR5021	Ceramic Stone Holder for Profilers, 3mm Shank	\$25.03
	02N-HDR5022	Ceramic Stone Holder for Profilers, 3/16" Shank	\$26.26
	02N-HDR5023	Brass Ring Replacement for Stone Holder	\$12.21
	02N-HDR5024	Large Brass Ring Replacement for Stone Holder	\$23.25
	02N-HDR5025	Holder for Profiler, Long, 3/16" Shank, for 1/4" stones	\$31.75
	02N-HDR5026	Holder for Profiler, Short, 3/16" Shank, for 1/4" stones	\$31.75
	02N-HDR5027	Holder for Profiler, Short, 3/16" Shank, for 1/8" stones	\$30.54
	02N-HDR5028	Holder for Profiler, 1/8" Shank, for 1/4" x 1/2" stones	\$14.58

Air Grinders	MODEL	DESCRIPTION	RPM	ORDER NO.	PRICE
	MSG-32BSN	Straight pencil type with 1/8" collet	65,000	09M-MSG0032	\$235.00
	MSG-3BSN	Straight pencil type with 3 mm collet	65,000	09M-MSG0003	\$235.00
	MAG-121N1/8	120° angle air grinder with 1/8" collet	52,500	09M-MAG0121	\$299.00
	MAG-122N	120° angle air grinder	35,000	09M-MAG0122	\$299.00
	MAG-123N	120° angle air grinder	23,500	09M-MAG0123	\$299.00
	MAG-093N	90° angle air grinder	23,500	09M-MAG0093	\$299.00

Grande BLH-600 Micromotor Electric Grinder



SET INCLUDES:

- 50,000 RPM Hand Piece with 1/8" Collet
- Hybrid Control Unit - Works with brushless and brush-type motors
- Speed Control Foot Pedal
- Hand Piece Holder (2 pcs)
- Collet Chuck Changing Jig Set

Brushless Motor Hand Piece Specifications

- Weight - 0.5 lbs
- Dimensions - 6.3" x 0.53" / 1" x 1.05" (Motor)
- Max RPM - 50,000

Control Unit Specifications

- Weight - 5.3 lbs
- Dimensions - 9.8" x 3.5" x 7.17"
- Voltage - 110 V - 120 V

Grande BLH-600 Micromotor Electric Grinder

09M-BLH0600
\$650.00

OPTIONAL ITEMS AVAILABLE

Collets

- 2.35 mm Collet - Item TPH65-117A
- 3.0 mm Collet - Item TPH65-117B

30 Piece Diamond Point Sets

- 2.35 mm Shank - Item DBS530-325
- 3.0 mm Shank - Item DBS530-300

Brush Type Motor Hand Pieces

- 35,000 RPM - Item PHP35
- 40,000 RPM - Item PHP40



Foredom Flexible Shaft Machine • SR

1/6 HP SERIES SR MOTOR

- Maximum Speed 18,000 RPM • Reversible
- The SR combines the most important features our customers expect — power, reversibility and reliability — into one motor.
- More Power: The 1/6 HP ball bearing Series SR has 33% more power than the 1/8 hp Series S and 66% more than the 1/10 hp Series CC. The added power helps to reduce stalling or slowing down under normal workloads.
- Reliability: The warranty has been extended to two years.
- Reversible: This is a great feature for lefties, and helps to keep debris flying away from — not toward — both right and left handed users. You can back out drill bits and extend the life of some abrasives by alternating direction. It is also good for accomplishing symmetrical grinding, carving, and polishing techniques.
- The SR uses standard flexible shafts and sheaths for connecting to any of Foredom's or Falcon's "quick disconnect" handpieces. See below for speed control options.
- Always wear proper eye protection while using rotary power tool accessories.



PRODUCT	ORDER NO.	PRICE	PRODUCT	ORDER NO.	PRICE
SR Reversible Motor Only	09E-FRM3301	\$191.00	SCT-1 Foot Control (Cast Iron)	09F-MTA1102	\$69.00
77 Outer Sheath	09F-MTA1001	\$15.00	EM-1 Table Top Dial Control	09F-MTA1105	\$69.00
93 Inner Cable (Standard Key Type Drive)	09F-MTA1000	\$11.00	UA111P Motor Connector (for SR)	09F-MTA1204	\$3.50
93-S Inner Cable (Square Drive for Heavy Duty Die Profiler)	09F-MTA1009	\$19.85	MK-10 Maintenance Kit (for SR)	09F-MTA1321	\$18.00
FCT-1 Foot Control (Plastic)	09F-MTA1100	\$35.00	132-P Motor Brushes (for SR)	09F-MTA1215	\$9.00
SR Set	09E-FRM3301	\$215.00	SR Motor with standard shaft & sheath. *Purchase speed controls separately		

Bench Model

This motor is also available as the following bench models. Number 09E-FRM3309 should be used with a speed control.



	ORDER NO.	PRICE	ORDER NO.	PRICE
Complete Machine	09E-FRM3309	\$245.00	09E-FRM3303	\$279.00
Motor Only	09E-FRM3302	\$191.00	09E-FRM3311	\$191.00
Bench Only	09F-MTA1201	\$49.00	09F-MTA1213	\$107.50

Bench Models include Motor, Stand, Sheath and Cable.

Foredom Power Tool & Accessory Catalog Available Upon Request.

Speed Controls for NEW 1/6 HP Series SR



Foot Control in Plastic Housing
FCT-1
09F-MTA1100
\$35.00

Foot Control in Cast Iron Housing
SCT-1
09F-MTA1102
\$69.00

Table Top Dial Control
EM-1
09F-MTA1105
\$69.00

Foredom Flexible Shaft Machine • LX

SERIES LX HIGH TORQUE/LOW SPEED (up to 5,000 rpm)

- This motor is ideal to operate the Die Profiler at its recommended speed without requiring a speed control on the motor.
- Series LX permanent magnet motors are specifically designed for low speed/high torque applications.
- The LX ball bearing motors offer full power and torque from start up and throughout the entire speed range up to 5,000 rpm.
- Series LX motors use standard length shafts and more flexible neoprene sheaths for connecting to any of our 20+ "quick disconnect" handpieces. See special speed control options below for operating Series LX motor only.
- Always wear proper eye protection while using rotary power tool accessories.

2 Year Warranty on Series LX Motors and Controls



UA111P Motor Connector

PRODUCT	ORDER NO.	PRICE	PRODUCT	ORDER NO.	PRICE
LX High Torque Motor Only	09E-FRM8300	\$220.00	SXR Foot Control (Cast Iron)	09F-MTA1113	\$85.00
77 N Outer Sheath (Neoprene)	09F-MTA1010	\$19.00	EMX Table Top Dial Control	09F-MTA1114	\$85.00
93 Inner Cable (Standard Key Type Drive)	09F-MTA1000	\$11.00	UA111P Motor Connector (for LX)	09F-MTA1204	\$3.50
93-S Inner Cable (Square Drive for Heavy Duty Die Profiler)	09F-MTA1009	\$19.85	MK-16 Maintenance Kit (for LX)	09F-MTA1322	\$22.00
TXR Foot Control (Plastic)	09F-MTA1112	\$55.00	319-P Motor Brushes (for LX)	09F-MTA1214	\$12.00 pr
LX Set	09E-FRM8309	\$240.00	LX Motor with sheath & cable. *Purchase speed controls separately		

Special Speed Controls for NEW Series LX High Torque/ Low Speed Motor



Foot Control in Plastic Housing
TXR
09F-MTA1112
\$55.00



Foot Control in Cast Iron Housing
SXR
09F-MTA1113
\$85.00



Table Top Dial Control
EMX
09F-MTA1114
\$85.00

This LX Motor is also available as a bench style machine with both a plain cast iron bench and a built-in speed control bench. Please call for additional information and prices.

Foredom Power Tool & Accessory Catalog Available Upon Request.



Foredom Flexible Shaft Machine • TX

SERIES TX 1/3 HP HIGH TORQUE AT ALL SPEEDS

- 2 Year Warranty on Series TX Motors and Controls
- Max Speed 15,000 RPM
- The TX is Foredom's most powerful flex shaft and is a permanent magnet DC motor featuring the newest in flex shaft technology. These ball bearing models utilize advanced rare earth magnets (in place of wound fields in our universal motors) that deliver more torque at low speeds and throughout the entire speed range. No other flex shaft machine gives you greater control of the cutting tool, drill, or bur under any load.
- The TX motors use standard 39" long flexible shafts and sheaths for connecting to any of Falcon's or Foredom's "quick disconnect" handpieces.
- Always wear proper eye protection while using rotary power tool accessories.

Note: All Series TX motors must be used with the speed controls below. They are similar in appearance to the others in our line, but have TX specific electronics for smoother acceleration and extra control of the tool.



PRODUCT	ORDER NO.	PRICE	PRODUCT	ORDER NO.	PRICE
TX 1/3 HP Motor Only	09E-FRM7000	\$241.00	SXR Foot Control (Cast Iron)	09F-MTA1113	\$85.00
77 Outer Sheath	09F-MTA1001	\$15.00	EMX Table Top Dial Control	09F-MTA1114	\$85.00
93 Inner Cable (Standard Key Type Drive)	09F-MTA1000	\$11.00	UA111P Motor Connector (for TX)	09F-MTA1204	\$3.50
93-S Inner Cable (Square Drive for Heavy Duty Die Profiler)	09F-MTA1009	\$19.85	MK-16 Maintenance Kit (for TX)	09F-MTA1322	\$22.00
TXR Foot Control (Plastic)	09F-MTA1112	\$55.00	319-P Motor Brushes (for TX)	09F-MTA1214	\$12.00 pr
TX Set	09E-FRM7011	\$265.00	TX Motor with standard sheath & cable. *Purchase speed controls separately		

Special Speed Controls for Series TX Motors

HIGH PERFORMANCE WITH SMOOTH AND CONTROLLED ACCELERATION UP TO 15,000 RPM

Three models of speed controls are available with special electronic circuitry required for controlling the TX permanent magnet DC motors.

This TX Motor is also available as a bench style machine with both a plain cast iron bench and built-in speed control bench. Please call for additional information and prices.



Foot Control in Plastic Housing
TXR
09F-MTA1112
\$55.00



Foot Control in Cast Iron Housing
SXR
09F-MTA1113
\$85.00



Table Top Dial Control
EMX
09F-MTA1114
\$85.00

Complete Foredom Power Tool & Accessory Catalog Available Upon Request.

Telescoping Right Angle Handpiece

Complete with 1/8" Collet

- A telescoping right angle handpiece that fits tools with 3/32" and 1/8" diameter shanks.
- The head drive can be rotated 360° and extended telescopically from an 8" length to an 11" length.
- The handpiece is especially suited for using rotating tools in grinding or polishing "blind spots", recesses and irregular shaped slots in molds and dies.

- The Falcon handpiece is a precision tool with a head spindle mounted on a needle bearing in front and on a ball bearing at the back. The separate spindles are mounted with a bearing at each end. The Falcon handpiece comes complete with 1/8" precision spring collet.
- Fits Foredom Flexible Shaft Machines, pages 110 & 111

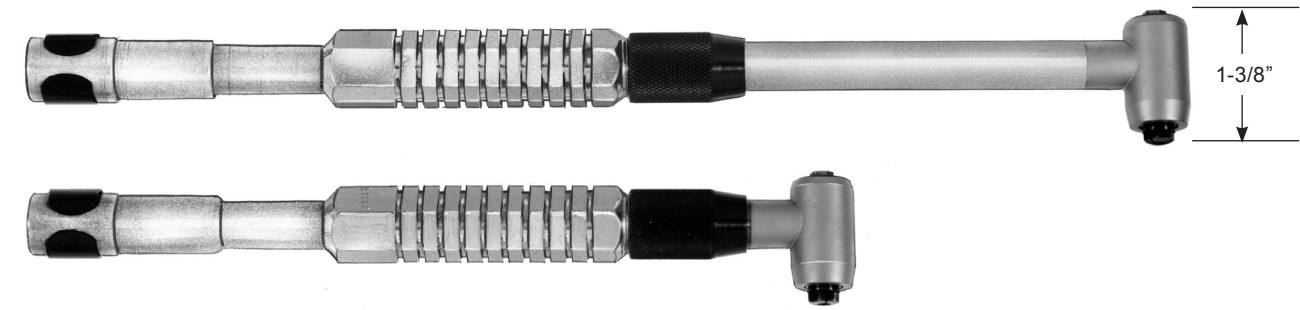

STYLE NO.	DESCRIPTION	ORDER NO.	PRICE
99	Telescoping Right Angle Handpiece	09A-FGH1000	\$638.00
—	3/32" Collet	09A-FGH1500	\$23.00 each
—	1/8" Collet	09A-FGH1501	\$23.00 each

Heavy Duty Right Angle Handpiece

Complete with 1/8" Collet

Call for parts list or replacement parts.

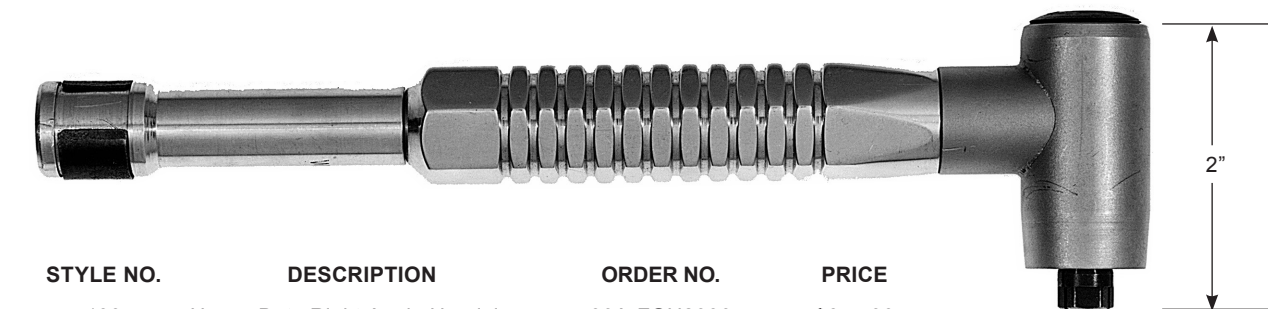

STYLE NO.	DESCRIPTION	ORDER NO.	PRICE
100	Heavy Duty Right Angle Handpiece	09A-FGH2000	\$645.00
—	3/32" Collet	09A-FGH2500	\$40.00 each
—	1/8" Collet	09A-FGH2501	\$41.80 each
—	1/4" Collet	09A-FGH2502	\$41.80 each

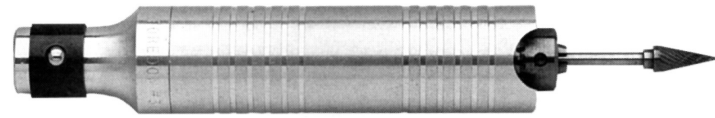

Foredom No. 30 09C-FRH2500 \$68.00

No. 30®

Foredom's most popular handpiece for general use. Geared 3-jaw Jacobs® chuck takes any size accessory shank or drill bit up to 5/32" in diameter. Prelubricated ball bearings require no maintenance. Comes with the CK-0 chuck key with molded plastic handle. 1" dia., 5-3/16" long.

CK-0 Chuck Key 09D-FRP1210 \$6.00

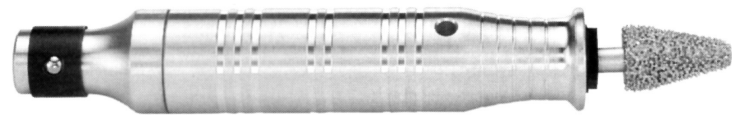

Foredom No. 44T 09C-FRH2800 \$60.00

No. 44T

This tapered grip handpiece is similar to No. 30® except that it has a collet-type chuck adaptable to larger accessories; seven collets from 1/16" to 1/4" available in Collet Set 440. Popular for roughing out and other operations requiring larger size accessories. Comes complete with 1/4" collet, pin and wrench for changing collets. Prelubricated ball bearings require no maintenance. 1" dia., 5-5/8" long. For maximum utility, purchase with No. 440 Collet Set shown on page 115.

103117 Pin & Wrench 09D-FRP1310 \$3.50

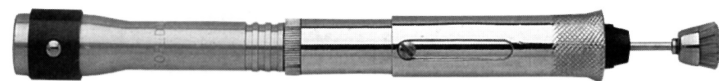

Foredom No. 8 09C-FRH1300 \$65.00

No. 8

A slim handpiece widely used for fine, detailed work. Its chuck guard sleeve protects fingers and permits close work. Guard slides back when changing accessories. Four collets, 1/32", 1/16", 3/32" (2.35mm) and 1/8" are available. Comes complete with 3/32" collet (unless other size is specified) and wrenches for changing collets. Prelubricated ball bearings require no maintenance. 3/4" dia., 6" long. For maximum utility purchase with Collet Set 600 shown on page 115.

Wrench Assy 09D-FRP1014 \$3.50



Foredom No. 8D 09C-FRH1400 \$90.00

No. 8D (Duplex)

Same as No. 8 with the added feature of a duplex spring drive connection and cover. 3/4" dia., 9-1/2" long.

Diameter is measured at handpiece's widest point. Length is measured from end of "QD" connector to tip of chuck or collet. Handpieces are not shown actual size.

These are Foredom's most popular handpieces. However, Foredom offers over 20 different quick disconnect handpieces. Please contact us for information on the complete Foredom line.

Collets for Handpieces

- A set of Foredom Precision Collets is an essential part of your Foredom Miniature Power Tool.
• A complete set permits the use of a wide range of accessory shank sizes within the capacity of the handpiece.

Collet Set 440 includes 7 sizes for use with Handpiece 44T

Table with 5 columns: FOREDOM NO., ORDER NO., NOMINAL CAP, RECOMMENDED RANGE, PRICE EACH. Lists items *441 through *449.

Collet Set 600 includes 4 sizes for use with Handpieces 8, 8D & 5

Table with 5 columns: FOREDOM NO., ORDER NO., NOMINAL CAP, RECOMMENDED RANGE, PRICE EACH. Lists items *601 through *604.



440 Collet Set

Set of 1 each of above for 44T Handpiece

Table with 3 columns: FOREDOM NO., ORDER NO., PRICE. Shows Set 440 for \$49.00.

The following collets are available but not included in 440 Collet Set

Table with 5 columns: FOREDOM NO., ORDER NO., NOMINAL CAP, RECOMMENDED RANGE, PRICE EACH. Lists items *445 and *446.



600 Collet Set

Set of 1 each of above for 8, 8D, and 5 Handpiece

Table with 3 columns: FOREDOM NO., ORDER NO., PRICE. Shows Set 600 for \$30.00.

The following collet is available but not included in 600 Collet Set

Table with 5 columns: FOREDOM NO., ORDER NO., NOMINAL CAP, RECOMMENDED RANGE, PRICE EACH. Lists item *605.



Freedom Sheath & Cable



Freedom No. 93 Order No. 09F-MTA1000 Inner Cable for Series SR, L, LX, TX, S, CC and R motors \$11.00

Freedom No. 93S Order No. 09F-MTA1009 Inner Cable same as above except has square end drive \$19.85



Freedom No. 77 Order No. 09F-MTA1001 Outer Sheath for Series SR, TX, S, CC and R motors \$15.00



Freedom No. 77N Order No. 09F-MTA1010 Flexible Neoprene Outer Sheath for Series L & LX Motor (Optional for others) \$19.00



Freedom No. 96A Order No. 09F-MTA1002 Inner Cable for 00066 and Series EE motors (Key both ends) \$11.00



Freedom No. 80 Order No. 09F-MTA1003 Outer Sheath for 00066 and Series EE motors \$15.00



Falcon No. 98 Order No.09F-MTA1004 Square End Inner Cable for 00066 and Series EE motors with FPH/R Heavy Duty Die Profiler (Use with No. 80 Outer Sheath above) \$19.00

CK-0 Chuck Key in Plastic Molded Handle



The comfortable plastic handle makes accessory changes easier and the key more difficult to misplace. Comes supplied with handpiece No. 30.

ORDER NO. 09D-FRP1210
\$6.00



Rheostat



The Variac® autotransformer is an efficient, trouble-free device for controlling ac voltage. Unlike most transformers, the Variac has a transformation ratio that can be smoothly and continuously changed so that the output of the unit can be controlled from zero to line voltage or even higher. Because it is a transformer, the Variac is: efficient, transforms power more efficiently than rheostats.

Variac® Autotransformer
MODEL NO. R-28
ORDER NO. 09F-MTA1111
5 Amp 0-140 Volt
Variat for Hand Speed Control
\$366.00

Heavy Duty Foot Rheostat

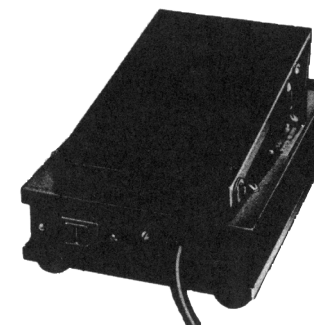

THIS IS THE SAME PEDAL WHICH HAS SATISFIED MANY CUSTOMERS FOR MANY YEARS.

- Standard value is 60 ohms
- Unparalleled reliability
- Rugged construction
- Reliable contact mechanism
- Metal oxide varistor protection

Heavy-Duty Foot Rheostat
MODEL NO. R-21
ORDER NO. 09F-MTA1110
5-6 Amp Capacity
Heavy-Duty Foot Rheostat
Price: \$275.00



BL Bench Lathe 1/6 Horsepower

13" Wide
Perfect for use at the bench



BL Bench Lathe with Tapered Spindles

Powerful variable speed bench lathe in a compact size suitable for use at the workbench. Its permanent magnet motor is extremely quiet and smooth running with all the power and speed required for a variety of polishing and buffing jobs.

Order No. 09E-FRM6200 \$215.00

Weight: 7.5 lbs. (3.4 kg.)

Width: 13" (330mm) between spindles

Height - overall: 5-1/8" (130mm)

Height of spindle center from table surface: 3-3/4" (95mm)

1/6 HP High Torque Motor
125 Watts (continuous rating)
5/16" Dia. Motor Shaft
Ball Bearing
500-7,000 RPM
One Year Warranty

Lathe Accessories



Tapered Spindles

For left and right hand mounting of buffs and wheels up to 4" diameter.

TM-5 left side for 5/16" shaft ORDER NO. 09E-FRM6201 \$11.00

TM-6 right side for 5/16" shaft ORDER NO. 09E-FRM6202 \$11.00

Plastic Spindle

For left and right hand mounting of buffs and wheels up to 4" diameter with 3/8" arbor hole.

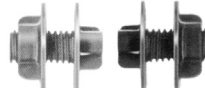

4562 left side ORDER NO. 09E-FRM6203 \$2.20

4561 right side ORDER NO. 09E-FRM6204 \$2.20

Hub Adapter for Tapered Spindles

For left and right hand mounting of wheels with 1" arbor holes. Use on BL lathe spindles and standard tapered spindles.



4568 ORDER NO. 09E-FRM6205 \$5.50

Collet Holder with 3 collets

Collet holder on arbor comes with 3/32", 1/8" and 1/4" collets, allen key, and pin & wrench for mounting various size shank mandrels, sanding drums, etc. For use only on right hand side.

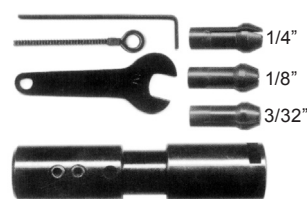

CHA-5 right side for 5/16" shaft ORDER NO. 09E-FRM6206 \$35.00

Chuck Arbor

Arbor adjusts to hold accessories with shank from 0-5/32". Comes with chuck key. For use only on right hand side.



JCA-2 right side for 5/16" shaft ORDER NO. 09E-FRM6207 \$49.00

Wheel Mandrels

Hold rubber bonded abrasive wheels, grindir stones, sanding drums, brushes and other accessories with 1/4" center mounting hole to 3/4" thick.

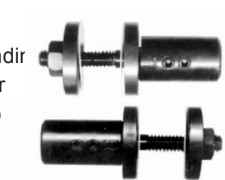

WM-5 left side for 5/16" shaft ORDER NO. 09E-FRM6208 \$17.00

WM-6 right side for 5/16" shaft ORDER NO. 09E-FRM6209 \$17.00

Routine Maintenance for your Foredom Flex Shaft Machine

Foredom motors are durable and built to industrial standards. But like many other quality machines, they require some basic maintenance to keep them running at optimum performance.

Routine Cleaning of Motors

It is important to routinely clean your Foredom Power Tool. Accumulation of dirt and dust is the most common cause of poor operation and excessive wear.

Air should be blown through the motor every 40 hours of use to remove dirt and dust.

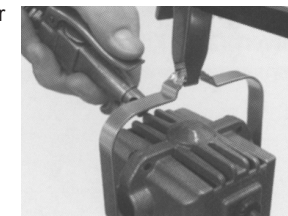

Replacement of Motor Brushes

The motor brushes should be checked for wear periodically. When new, they are approximately 3/4" (19mm) long. Replace them when they have worn to 1/4" (6mm).

To remove brushes, disconnect motor power cord and unscrew the brush caps.

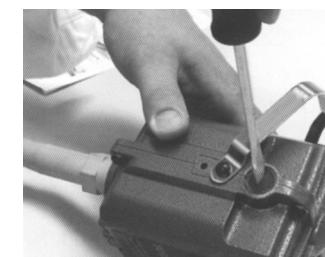

Routine Cleaning and Lubrication of Flexible Shaft

The shaft should be checked, wiped clean, and re-lubed with grease every 50 hours of use. With every 200 hours of use, the shaft should be thoroughly cleaned with solvent and lubricated.

A. With the handpiece removed, loosen the set screw and slide sheath out of the motor connector.

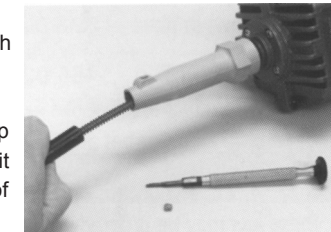

B. Apply a very light coating of grease to the shaft. If too much grease is applied, the excess will work its way into the handpiece and eventually seep out. For this reason, apply a bit less near the handpiece end of the shaft.

C. Replace and adjust sheath so that shaft key tip extends 3/4" (19mm) from the sheath. Retighten the set screw in motor connector.



D. Clean exterior of sheath by wiping with a cloth.

E. Hang and run the motor for about 10 minutes before reattaching the handpiece to allow enough time for the grease to warm up, spread and drain off. Wipe off any excess grease at tip end of the sheath.

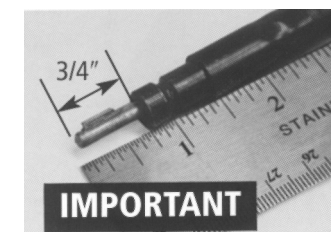

Never run the motor with the outer sheath removed.

Flexible Shaft Handpiece Motor Oil

STYLE NO. 110
ORDER NO. 09F-MTA1300
2 oz. Bottle
\$3.00



Flexible Shaft Grease

STYLE NO. 310
ORDER NO. 09F-MTA1302
1 oz. Tube
\$3.50



Motor Oil

STYLE NO. 210
ORDER NO. 09F-MTA1301
Oil in Refillable Hypodermic Dispenser
\$4.50





Heavy Duty Profiler Model FPH/R

FEATURES:

- Fitted with ergonomic cushion grip for better comfort.
- Variable speed of reciprocation from 0-14,000 strokes per minute.
- Length of stroke adjustable from 0 to 1/4 inch.
- Spring cushioned to prevent damage to work piece, tool or Die-Profiler.
- Sturdy construction for long trouble-free operation.
- Easy adjustments for fast, precise work.
- Completely versatile, parts are easily interchangeable.

ADVANTAGES:

- Vibration-free operation — assures perfect control for intricate operations.
- Eliminates tedious hand labor.
- Fast, easy to use.
- Light weight — eliminates operator fatigue.

FOR: Filing, Honing, Deburring, Lapping, Polishing, or reworking hardened materials, finishing complicated dies and molds, and other similar jobs.

The Die Profiler FPH/R is an all-new Die-Profiler that will accept up to 1/4" shank tools. The new unit features larger sealed bearings, a massive new-design connecting rod and front end. Guiding surface area has been more than tripled. Repair costs and downtimes are dramatically reduced without sacrificing any of the ultra smooth, lightweight features of our present machine. Includes plastic fitted case.

ORDER NO. 09G-DPF2000 \$1,188.00 *Call for parts list

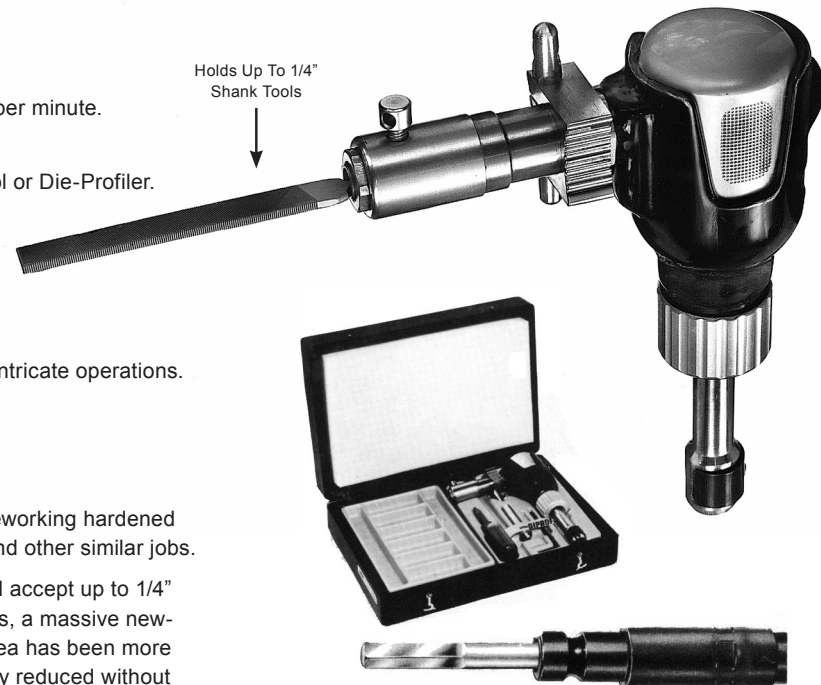

Holds Up To 1/4" Shank Tools

SQUARE DRIVE – Provides long lasting, positive drive. Ask about our adapters and inner cables for key-type shaft motors.

Complete Set FPH/R Heavy Duty Die Profiler

Complete Set Order No. 09G-DPF2001 \$1,436.95



FPH/R Heavy Duty Profiler



Series SR Motor Motor is reversible 18,000 RPM Motor



FCT-1 Foot Control

INCLUDES THE FOLLOWING PLUS:

- 93S Square Drive Inner Cable
- 77 Outer Sheath
- Plastic Case for FPH Head

Sets may be assembled with other motors and controls if preferred. Please inquire. See page 111-112 for optional motor stand & speed controls.

Falcon Polishing Stone Holders

For die profiling machines • 1/8" shank

FOR STONES IN FOLLOWING SIZES:	1/16"	3/32"	3/16"	1/4"
ORDER NO.	09G-DPF3000	09G-DPF3001	09G-DPF3003	09G-DPF3004
PRICE EACH	\$5.30	\$5.30	\$5.30	\$5.30

Fits square or rectangular shapes

Dumore Series 10 Deluxe Hand Grinder

This is the industry's most popular grinder for precision tool and die and all-around use.

The advanced design Dumore motor is more efficient, conserves power and runs cooler, with two sealed grease lubricated ball bearings. Precision chucks allow fast changeover and minimize runout. Rear mounted "on-off" switch provides additional operator safety.

- 1/10 HP universal motor
- 22,000 RPM grinder
- 1" max. diameter wheel capacity
- Now available in a handy, all-in-one kit



Kit price is less than cost of grinder alone!

Series 10 Hand Grinder with 5/32" capacity Jacobs chuck

ORDER NO. 09I-DUG2000 Series 10-321 \$349.00

Dumore Brass Reducing Collet 1/4" x 1/8"

PART NO. 503-0012 ORDER NO. 09I-DUG3100 \$9.60



Series 10 Deluxe Hand Grinder Kit

#10-355 with Series 10-351 Grinder Contains both 1/4" and 1/8" precision chucks, 8 mounted wheels for grinding and deburring, dressing stone, 1" diameter cut-off wheel with arbor, wrenches, carrying case.

ORDER NO. 09I-DUG1100 \$345.00

Series 35 • 1/4 HP Grinder • Dumore 35-171

For continuous duty with mounted wheels on all industrial applications

35,000 RPM, Dumore manufactured motor provides ample power to handle grinding applications using rotary files. Three precision grease lubricated bearings give rigid spindle support for extended use and minimal run-out. Rear mounted "on-off" switch prevents accidental tripping. Die-cast aluminum housing is lightweight, yet strong and durable. Two-piece collet for quick tool change.

- Motor: 1/4 HP Universal
- Speed: 35,000 RPM
- Chuck: 1/4" collet type with 1/8" reducing sleeve
- Spindle: 7/16 - 32 threaded
- Wheel Capacity: One-inch diameter grinding wheel
- Weight: Net 3 lbs., 8 oz., Ship. Wt. 5 lbs.
- Diameter: Major 2-3/4", chuck end 1-1/4"
- Length: 11"
- Power Source: 115 V, AC/DC

Series 35 Hand Grinder 35-171

ORDER NO. 09I-DUG4000 \$640.00





Dumore Series 6 Flexible Shaft Grinder • 1/4 HP

Intended for heavy-duty metal removal with larger mounted wheels or rotary files. Powerful permanent magnet motor maintains speed under load.

Dumore built 1/4 HP permanent magnet ball bearing motor supplies 15,000 RPM under full load. 14-ounce precision handpiece runs cool, has grease sealed bearings to resist abrasive dust. Flexible shaft has metal clad ends to resist moisture, oil and grease. Wrench and pin collet removal provides quick tool changes. Swivel plate allows bench, stationary, or hang mounting.



- Motor: 1/4 HP Permanent Magnet
- Speed: 15,000 RPM Full Load
- Chuck: 1/8" and 1/4" collets
- Weight: Net 9 lbs., 8 oz., Ship. Wt. 11 lbs.
- Power Source: 115 V, AC/DC

EQUIPMENT INCLUDED:

- 6-031 motor
- 6-214 flexible shaft
- 2-206 handpiece
- Chuck wrench
- Chuck locking pin
- Swivel base
- 8 ft. cord with 3-prong plug

OPTIONAL ACCESSORIES:

- **Foot Rheostat**
ORDER NO. 09I-DUG5800
\$164.00
- **Manual Speed Control**
ORDER NO. 09I-DUG5801
\$290.00

Complete Set Dumore 6-411

ORDER NO. 09I-DUG5000
\$970.00

High speed (26,000 RPM) version of above also available from Dumore as 6-511 Flexible Shaft Grinder.

Dotco Pencil Grinders

60,000 RPM • Rear Exhaust • Low Noise
Silk-Smooth Spindle • High Power

PENCIL GRINDER FEATURES:

- Rear Exhaust with flexible overhose for ultra-quiet operation (78 dBA) and safety (no blow back of chips and dust).
- 60,000 RPM for micro finishes.
- Precision collet for silk-smooth operation, long cutter life and minimum fatigue.
- Small size for minimum fatigue, ultimate control and easy access to confined areas.
- Rotary vane motor for maximum power.
- Stainless steel and brass construction for protection against corrosion.
- Precision stainless steel ball bearings are shielded type for long life.
- Roll throttle for variable-speed control.
- Use with: Carbide burs and diamond pins up to 1/4" diameter with 1/8" or 3/32" shanks. Mounted wheels should have a "safe speed" rating of 60,000 R.P.M. or higher.

APPLICATIONS:

Designed for continuous duty precision die grinding, intricate deburring of machined parts, production grinding of small castings and for precise weld removal.

Optional Equipment Available at Extra Cost

DOTCO NO.	DESCRIPTION	ORDER NO.	PRICE
02	3/32" Collet	09L-DOP1001	\$31.60
103	1/16" Collet	09L-DOP1265	\$128.00
45-6002	2' Over Hose	09L-DOP1289	\$24.70
45-6001	4' Over Hose	09L-DOP1288	\$42.10

Metric collets available from factory stock.

Pencil Grinder rebuild kit includes bearings, rotor blades, spacers, etc. for one complete rebuild.

Turbine Grinder

100,000 RPM • Front Exhaust • Oil Free

Standard Equipment Included With Grinder

DOTCO NO.	DESCRIPTION	ORDER NO.	PRICE
100	1/8" Collet	09L-DOP1000	\$31.60
45-1307	7' Air Hose	09L-DOP1232	\$28.10
45-0211	Filter w/Cartridge	09L-DOP1217	\$35.80
45-0212	Rep'l. Cartridge	09L-DOP1218	\$17.30
14-0803	3/16" Collet Wrench	09L-DOP1172	\$6.30
14-0804	1/4" Spindle Wrench	09L-DOP1173	\$7.50

Optional Equipment Available at Extra Cost

DOTCO NO.	DESCRIPTION	ORDER NO.	PRICE
102	3/32" Collet	09L-DOP1001	\$31.60
103	1/16" Collet	09L-DOP1265	\$128.00
14-1280	Collet Guard	09L-DOP1180	\$46.20

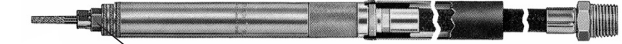

Model 10R0400A (Without Collet Guard), Order No. 09K-DOG1041

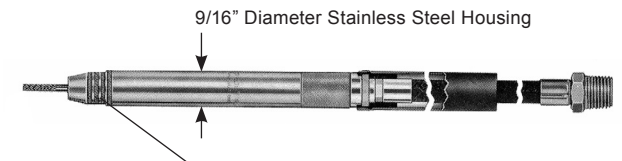

Model 10R0401A (Includes Collet Guard), Order No. 09K-DOG1042

DOTCO NO.	ORDER NO.	WEIGHT	LENGTH	PRICE
10R0400A-18	09K-DOG1041	3-3/4 oz.	5-3/4"	\$529.00
10R0401A-18	09K-DOG1042	3-3/4 oz.	5-3/4"	\$529.00

1/8" collet is included, 3/32" may be substituted on request.

Standard Equipment Included with Grinder

DOTCO NO.	DESCRIPTION	ORDER NO.	PRICE
100	1/8" Collet	09L-DOP1000	\$31.60
45-6013	Complete Hose Ass'y.	09L-DOP1270	\$56.00
45-0948	5' Air Hose	09L-DOP1226	\$31.50
45-6003	1' Over Hose w/Spring	09L-DOP1260	\$13.80
6061	Over Hose Spring Only	09L-DOP1146	\$8.20
14-0803	3/16" Collet Wrench	09L-DOP1172	\$6.30
14-0822	11/32" Spindle Wrench	09L-DOP1178	\$7.50
1830	Collet Guard (10R0401)	09L-DOP1112	\$12.70

Note: Models prior to 1/1/95 have old style throttle valve ass'y and over hose.



DOTCO NO.	ORDER NO.	RPM @ 90 PSI	WEIGHT	LENGTH	SPINDLE OFFSET	PRICE
10R9000-08	09K-DOG1043	100,000	9 oz.	5"	9/16"	\$627.00

Precision-built to do more work at high speed for super-finish work. Minimum runout and freedom from vibration for micro finishes without operator fatigue. Used with diamond wheels and points, carbide burs to 1/8" diameter, and small mounted wheels. Precision collet.

The DOTCO 2-stage turbine grinder is a high-speed, precision power package with a dependable DOTCO air motor, which is recognized as unexcelled for construction and durability. For fine die finishing, deburring and close-tolerance removal of workpiece materials. With the ultra-precision spindle, this tool will yield fine micro finishes.

CAUTION: Use dry air at 90psi (maximum); Do not lubricate, lubrication will be detrimental to the operation and life of this tool.



Medium Duty .3 HP Front Exhaust Grinder

Dotco Series 10-10 motors are compact, light in weight, giants in power. These rugged motors outperform in power and accuracy any pneumatic tool of comparable size and weight. The rotary vane air motors run cool, quiet and vibration free and have adjustable speed control. Spindle run-out is held to .0005 maximum for true-running operation. Erickson collets maintain minimum runout under load. Patented contour design with machined serrations make it easy to grip even with oily hands, for less operator fatigue. Sealed front ball bearings and micro-bronze muffler-filter keep out dirt and protect motor. The housing is machined from solid bar stock of high alloy aluminum for minimum wear and distortion. Air inlet is 1/4" female N.P.T.F.

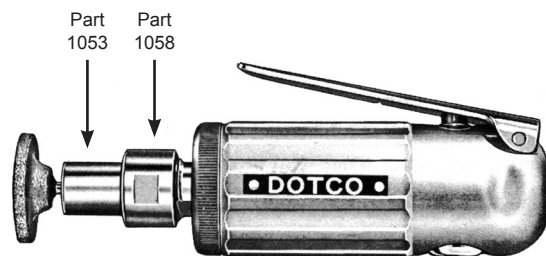

LEVER THROTTLE MODEL NO.	ORDER NO.	SPEED RPM @ 90 PSI	ERICKSON COLLET SERIES	WEIGHT	LENGTH	OFF-SET (SIDE TO CENTER)	AIR EXHAUST	PRICE
10L1000A-36	09K-DOG1018	30,000	300	12 ozs.	4-3/4"	21/32"	Front	\$466.00
10L1001A-36	09K-DOG1020	34,000	300	12 ozs.	4-3/4"	21/34"	Front	\$466.00
10L1003A-36	09K-DOG1021	25,000	300	12 ozs.	4-3/4"	21/32"	Front	\$466.00

1/4" collet is included. Any series 300 collet 3/32" thru 7/32" may be substituted on request. Locking button throttle, rear exhaust and ergonomic models are available from factory stock.

Standard & Optional Equipment

DOTCO NO.	DESCRIPTION	ORDER NO.	PRICE	DOTCO NO.	DESCRIPTION	ORDER NO.	PRICE
14-0807	7/16" Wrench	09L-DOP1175	\$6.30	201896PT	Collet Nose Cap Piece	09L-DOP1295	\$35.00
14-0811	11/16" Wrench	09L-DOP1247	\$7.80	1020	Long Collet Guard	09L-DOP1062	\$30.90
				14-2188	Noise Suppressor Guard	09L-DOP1278	\$24.40

Medium Duty .3 HP Front Exhaust Extension Grinder

Dotco Series 10-11 Motors are similar to Dotco Series 10-10 Motors except that they have extended spindles with two additional precision ball bearings in the extension housing. The outside diameter of the extension housing is only 3/4", which permits grinding and deburring in small diameter holes. Spindle run-out is held to .0005 maximum for true-running operation. Patented contour design with machined serrations makes it easy to grip even with oily hands, for less operator fatigue. Sealed front ball bearings keep out dirt, protect the motor. Motor housing is machined from solid bar stock of high alloy aluminum. Extension housing is chrome-plated steel. Air inlet is 1/4" female N.P.T.F.

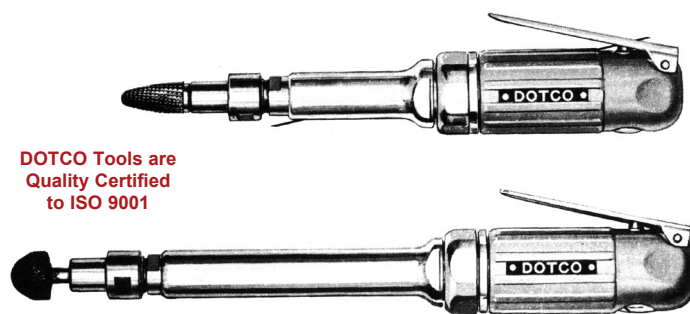

DOTCO Tools are Quality Certified to ISO 9001

LEVER THROTTLE MODEL NO.	ORDER NO.	SPEED RPM @ 90 PSI	ERICKSON COLLET SERIES	WEIGHT	LENGTH	OFF-SET (SIDE TO CENTER)	PRICE
10L1100B-36	09K-DOG1024	28,000	300	16 oz.	7-5/8"	21/32"	\$735.00
10L1101B-36	09K-DOG1025	28,000	300	18 oz.	9-5/8"	21/32"	\$755.00
10L1111B-36	09K-DOG1026	25,000	300	16 oz.	7-5/8"	21/32"	\$735.00
10L1112B-36	09K-DOG1027	25,000	300	18 oz.	9-5/8"	21/32"	\$755.00

1/4" collet is included. Any series 300 collet 3/32" thru 7/32" from page 248 may be substituted on request. Locking button throttle, rear exhaust and ergonomic models are available from factory stock.

DOTCO Heavy Duty .6 HP Front & Side Exhaust Grinders

Dotco Series 10-20 Motors are larger and more powerful than the Series 10-10 Motors. These rugged motors outperform in power and accuracy any pneumatic tool of comparable size and weight. The rotary vane air motors run cool, quiet and vibration-free and have adjustable speed control. Spindle run-out is held to .0005 maximum for true-running operation. Erickson collets maintain

minimum run-out under load. Patented contour design with machined serrations make it easy to grip even with oily hands, for less operator fatigue. Sealed front ball bearings and micro-bronze muffler-filter keep out dirt and protect the motor. The housing is machined from solid bar stock of high alloy aluminum for minimum wear and distortion. Air inlet is 1/4" female N.P.T.F.



Model 10L2000C-01 and 10L2005C-01



Model 10L2008C-01 Side Exhaust with Optional Collet Guard



Model 10L2000C-36 with Extended Collet Chuck for Series 300 Collets

LEVER THROTTLE MODEL NO.	ORDER NO.	SPEED RPM @ 90 PSI	ERICKSON COLLET SERIES	WEIGHT	LENGTH	OFF-SET (SIDE TO CENTER)	AIR EXHAUST	PRICE
10L2000C-01	09K-DOG1032	25,000	200	20 oz.	5-3/4"	13/16"	Front	\$556.00
10L2005C-01	09K-DOG1034	20,000	200	20 oz.	5-3/4"	13/16"	Front	\$556.00
10L2000C-36 (was 10L2015)	09K-DOG1033	25,000	300	20 oz.	6-7/16"	13/16"	Front	\$572.00

1/4" collet is included. Other collets from page 248 may be substituted on request. Locking button throttle, rear exhaust and ergonomic models are available from factory stock.

Right Angle Grinder .3 HP Front Exhaust Grinders

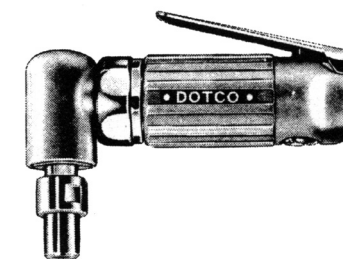

Compact, rugged and extremely easy to use for deburring, blending and contouring — fits the hand like a glove providing excellent control and highest productivity with minimum fatigue. Compact for finishing hard-to-reach areas...for example, maintenance of dies without removal from press. Air inlet — 1/4" female NPTF. Use 1/4" I.D. hose, or larger.

USE WITH: Sanding discs up to 3" diameter in 12,000 RPM models--up to 2" in 20,000 RPM models. Also, small mounted wheels, carbide burrs up to 1/2", cartridge rolls, felt bobs, etc.

DOTCO Tools are Quality Certified to ISO 9001

LEVER THROTTLE MODEL NO.	ORDER NO.	RPM @ 90 PSI	ERICKSON COLLET SERIES	WEIGHT	LENGTH	ANGLE HEAD HEIGHT	PRICE
10L1200B-36	09K-DOG1029	12,000	300	15 oz.	4-7/8"	2-29/32"	\$696.00
10L1201B-36	09K-DOG1030	20,000	300	15 oz.	4-7/8"	2-29/32"	\$696.00

1/4" collet is included. Other collets from page 248 may be substituted on request. Locking button throttle, rear exhaust and ergonomic models are available from factory stock.

Standard & Optional Equipment

DOTCO NO.	ORDER NO.	DESCRIPTION	PRICE	DOTCO NO.	ORDER NO.	DESCRIPTION	PRICE
14-0807	09L-DOP1175	7/16" Wrench	\$6.30	45-1982	09L-DOP1240	Plastic Grease Gun	\$17.90
14-0811	09L-DOP1247	11/16" Wrench	\$7.80	45-0980	09L-DOP1230	Gear Lube	\$5.80



DOTCO Precision Hole Grinder

- High-speed drilling & grinding of hardened alloys
- Fine cutting of thin wall sections
- Materials too fragile for conventional methods
- Use on lathes, grinders, mills, or drills presses for straightline machining
- Insert in a boring head for offset jig grinding
- Mount permanently for special applications

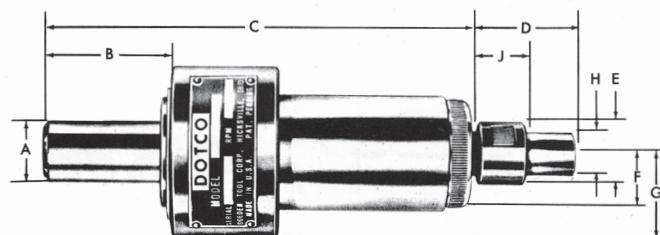

MODEL NO.	ORDER NO.	SHANK DIA. "A"	MOTOR SPEED @ 90 PSI	HORSE POWER	NET WT. LBS	ERICKSON COLLET SERIES	B	C	D	E	F	G	H	J	PRICE
11Q1002	09K-DOG1046	3/4	30,000	0.3 HP	2	300	15/16	4-13/16	1-1/4	3/4	11/16	1	1/2	11/16	\$790.00
11Q2000	09K-DOG1047	1/2	25,000	0.6 HP	3	200	15/16	6-1/4	1-1/8	13/16	13/16	1	13/16	1-1/8	\$900.00
11Q2002	09K-DOG1049	3/4	25,000	0.6 HP	3	200	15/16	6-1/4	1-1/8	13/16	13/16	1	13/16	1-1/8	\$900.00

Collets



Erickson Series 200 Collets

STYLE NO.	ORDER NO.	SIZE	CAPACITY		PRICE
			MIN.	MAX.	
204	09L-DOP1006	1/8"	3/32"	1/8"	\$24.70
205	09L-DOP1007	5/32"	1/8"	5/32"	\$24.10
206	09L-DOP1008	3/16"	5/32"	3/16"	\$24.70
207	09L-DOP1009	7/32"	3/16"	7/32"	\$24.70
208	09L-DOP1010	1/4"	7/32"	1/4"	\$24.70
209	09L-DOP1011	9/32"	1/4"	9/32"	\$24.70
210	09L-DOP1012	5/16"	9/32"	5/16"	\$24.10
212	09L-DOP1014	3/8"	11/32"	3/8"	\$24.70



Erickson Series 300 Collets

STYLE NO.	ORDER NO.	SIZE	CAPACITY		PRICE
			MIN.	MAX.	
301	09L-DOP1015	3/64"	1/64"	3/64"	\$59.00
302	09L-DOP1016	5/64"	3/64"	5/64"	\$59.00
303	09L-DOP1017	3/32"	1/16"	3/32"	\$24.70
304	09L-DOP1018	1/8"	3/32"	1/8"	\$24.10
305	09L-DOP1019	5/32"	1/8"	5/32"	\$24.10
306	09L-DOP1020	3/16"	5/32"	3/16"	\$24.10
307	09L-DOP1021	7/32"	3/16"	7/32"	\$24.10
308	09L-DOP1022	1/4"	7/32"	1/4"	\$24.10

Filter • Regulator • Lubricator

Standard Air Line Units for Medium and Heavy-Duty Air Tools

STYLE NO.	ORDER NO.	DESCRIPTION	PIPE SIZE	LUBRICATOR CAPACITY	MAXIMUM CFM	PRICE
45-0200	09L-DOP1254	Lubricator	1/4	7.1 oz.	35	\$65.50
45-0210	09L-DOP1255	Filter	1/4	—	30	\$52.60
45-0220	09L-DOP1256	Filter-Lubricator	1/4	7.1 oz.	30	\$120.20
45-0230	09L-DOP1257	Reg.-Gage	1/4	—	—	\$67.95
45-0240	09L-DOP1258	Filter-Lubricator-Regulator-Gage	1/4	7.1 oz.	30	\$193.20
275Y-160	09L-DOP1259	Gage only	1/4	—	0-125 psi	\$13.75

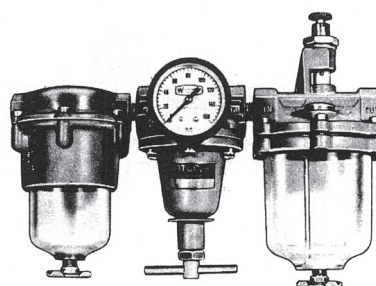

Flexible Air Hose

STYLE NO.	ORDER NO.	DESCRIPTION	HOSE SIZE	LENGTH	FITTINGS	PRICE
45-1408	09L-DOP1233	Original Equipment Flexible Air Hose with Braided Cover	1/4"	8'	1/4 x 1/4	\$34.20
45-1408A	09L-DOP1248	Durable Heavy Duty Replacement Rubber Hose	3/8"	8'	1/4 x 1/4	\$34.20



High Speed Die Grinders

Slim and Compact for Control and Precision Yet Extremely Powerful

High speed, powerful Die Grinders perfect for use with our carbide burs, mounted points and other abrasives.



Pencil Die Grinder

Straight pencil type with maximum speed of 75,000 RPM. Slim body design for intricate work and small diameter to facilitate precise control. 1/8" standard collet with 3/32", 3mm and 2.34mm collet options available. Removable collet guard for increased control and spindle protection.

ORDER NO. 09M-PDG1000

\$580.00

FEATURES & BENEFITS

- Slim body design - for intricate work
- High speed - Fine finish
- Small diameter facilitates precise control
- Removable Collet Guard
- Collet Guard for improved Control & Spindle Protection

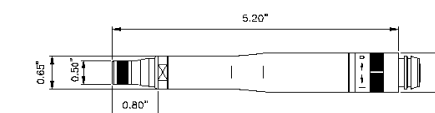

High Speed Die Grinder

Compact Die Grinder with a maximum speed of 45,000 RPM. 1/4" standard collet with 1/8", 6mm and 3mm collet options available. Hybrid design offers the best of a pencil grinder and standard die grinder. Powerful for digging out defects. Simple lever operation for when use is not continuous. Includes ergo sleeve fitted for operator comfort.

ORDER NO. 9M-PDG1001

\$675.00

FEATURES & BENEFITS

- Very compact
- Hybrid design offers the best of a pencil grinder and standard die grinder
- Powerful for digging out defects
- Simple lever operation best for where use is not continuous
- Ergo sleeve fitted for operator comfort

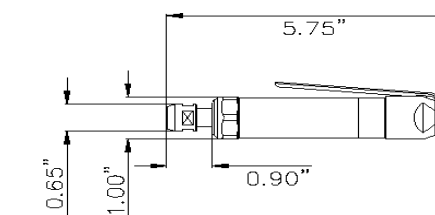

OptiVISOR
Optical Glass Binocular Magnifier

SPECIAL FEATURES:

- Leaves both hands free and tilts up when not in use
- Optical polished glass lens
- Adjusts to all head sizes and has leather comfort band
- Can be worn over prescription or safety glasses



MODEL NO.	ORDER NO.	MAGNIFICATION	FOCAL LENGTH	PRICE
DA-2	10K-OPT1002	1-1/2 times	20"	\$39.95
DA-3	10K-OPT1003	1-3/4 times	14"	\$39.95
DA-4	10K-OPT1004	2 times	10"	\$39.95
DA-5	10K-OPT1005	2-1/2 times	8"	\$39.95
DA-7	10K-OPT1007	2-3/4 times	6"	\$43.25
DA-10	10K-OPT1010	3-1/2 times	4"	\$43.25

Above prices include dial adjustable headband.

LED Light Kit illuminates holes, ribs & cavities
Add an LED light kit to your OptiVISOR with over 100,000 hour life expectancy. Reduces shadows and increases visibility in any environment.

10K-OPT9000 \$24.95



PART NO.	ORDER NO.	OPTIVISOR PARTS	PRICE
1	10K-OPT1100	Lens Plate No. 2	\$28.50 ea.
	10K-OPT1101	Lens Plate No. 3	\$28.50 ea.
	10K-OPT1102	Lens Plate No. 4	\$28.50 ea.
	10K-OPT1103	Lens Plate No. 5	\$28.50 ea.
	10K-OPT1104	Lens Plate No. 7	\$29.50 ea.
3	10K-OPT1105	Lens Plate No. 10	\$29.50 ea.
	10K-OPT1110	Leather Comfort Band	\$5.75
4	10K-OPT1106	Adjustable Pivot Assembly (2 sets required) per set	\$5.75 per set
5	10K-OPT1107	Headband Model E (specify color)	\$7.50 ea.
6	10K-OPT1108	Elastic Band with Slides	\$3.30 ea.
7	10K-OPT1109	Headband with dial adjustment, Model DA	\$12.80 ea.
DA-0	10K-OPT1000	OptiVISOR without Lens Plate	\$19.75
DA-HBL	10K-OPT1011	Headband w/ Leather Comfort Band	\$11.65
	10K-OPT9000	OptiVISOR LED Light Kit (Includes 2 AA Batteries)	\$24.95

OptiLOUPE

Special Features:

- Adds the power of an eye loupe to your OptiVISOR
- Easily attaches to either eye
- Provides an additional 2-1/2X magnification

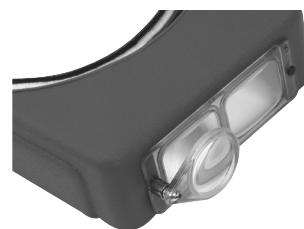

10K-OPT1001
\$11.95



Rib Lights

Rib lights are high intensity LED pen lights for polishers and mold makers. Excellent for illuminating ribs and slots. Available in Standard Pen Light or Bendable Gooseneck Style. Choose White or Blue LED light in Pen Light Style.

Includes 3 AAAA Batteries

ORDER NO.	DESCRIPTION	STYLE	PRICE
10R-RIB1001	Rib Light - Blue LED	Straight Pen	\$25.65
10R-RIB1002	Rib Light - White LED	Straight Pen	\$25.65
10R-RIB1003	Rib Light Reach - White LED	Flexible Neck	\$35.01
10R-RIB1000	Rib Light Battery - AAAA (3 per bag)	N/A	\$1.75

Falcon Jewelers' Saw Blades



QUANTITY DISCOUNTS
144+ OF SAME 17%

ORDER NO.	SIZE	THICK	WIDTH	PRICE PER DOZEN
10N-JSB1000	4/0	0.008	0.017	\$3.84
10N-JSB1001	3/0	0.010	0.019	\$3.48
10N-JSB1002	2/0	0.010	0.020	\$3.48
10N-JSB1003	1	0.012	0.025	\$3.48
10N-JSB1004	2	0.014	0.027	\$3.48
10N-JSB1005	3	0.014	0.029	\$3.48
10N-JSB1006	4	0.015	0.031	\$3.48
10N-JSB1007	5	0.016	0.034	\$3.84
10N-JSB1008	6	0.019	0.041	\$4.08
10N-JSB1009	8	0.020	0.048	\$4.80
10N-JSB1010	10	0.020	0.058	\$5.52
10N-JSB1011	12	0.023	0.064	\$6.24
10N-JSB1012	14	0.024	0.068	\$6.48

Saw frames available



MetalRustGuard

Rust and Corrosion Inhibitor

Non-toxic protective wrap to prevent rust and corrosion on any type of metal. Contains no VOC's or harsh chemicals in it's manufacturing. Can be used on the installation of any metal without harm to the user applying it or the environment it is placed in.

PRODUCT FEATURES

- Non-Toxic • Environmentally Safe • No Prep or Set Up • High Dead-Fold • Very Conformable • Strong Rust Inhibitor
• Bacteria Resistant • Effective in all Atmospheres • Easy to Apply • Easy to Remove • Abrasion Protection

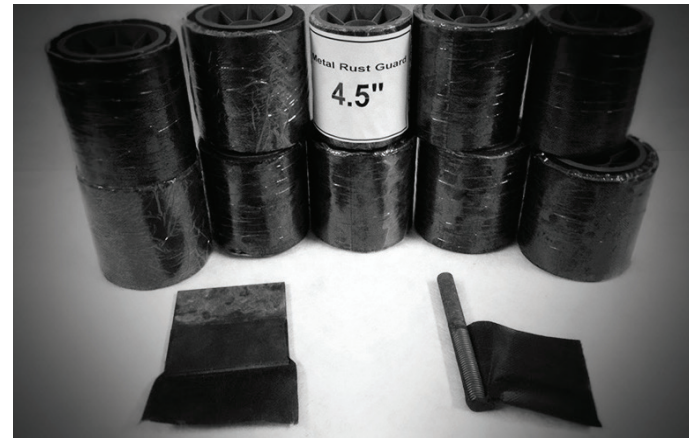
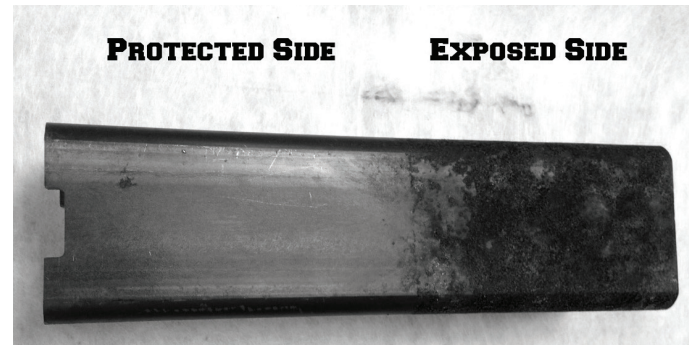

Table with 3 columns: ITEM, DIMENSIONS, LIST PRICE. Lists items 10S-MRG1000 through 10S-MRG1005 with their respective dimensions and prices.



FALCON CONVERSION TABLE

FOR CHANGING INCH FRACTIONS AND DECIMALS TO MILLIMETER EQUIVALENTS

Large conversion table with 12 columns: FRACT., INCHES, MM, FRACT., INCHES, MM, FRACT., INCHES, MM, FRACT., INCHES, MM. Provides conversion values for various fractions and decimals.

FalconTool.com

